



NEO-M8U

**u-blox M8 Untethered Dead Reckoning module including
3D inertial sensors**

Data Sheet



Abstract

This data sheet describes the NEO-M8U module, which provides leading performance and continuous navigation even with poor GNSS signal conditions. It functions independently of any electrical connection to the car.

Document Information

Title	NEO-M8U	
Subtitle	u-blox M8 Untethered Dead Reckoning module including 3D inertial sensors	
Document type	Data Sheet	
Document number	UBX-15015679	
Revision and date	R06	15-Feb-2018
Document status	Product Information	

Product status	Corresponding content status	
In Development / Prototype	Objective Specification	Target values. Revised and supplementary data will be published later.
Engineering Sample	Advance Information	Data based on early testing. Revised and supplementary data will be published later.
Initial Production	Early Production Information	Data from product verification. Revised and supplementary data may be published later.
Mass Production / End of Life	Production Information	Document contains the final product specification.

This document applies to the following products:

Product name	Type number	ROM/FLASH version	PCN reference
NEO-M8U	NEO-M8U-04B-00	Flash FW 3.01 UDR 1.21	N/A

u-blox or third parties may hold intellectual property rights in the products, names, logos and designs included in this document. Copying, reproduction, modification or disclosure to third parties of this document or any part thereof is only permitted with the express written permission of u-blox.

The information contained herein is provided "as is" and u-blox assumes no liability for its use. No warranty, either express or implied, is given, including but not limited to, with respect to the accuracy, correctness, reliability and fitness for a particular purpose of the information. This document may be revised by u-blox at any time without notice. For the most recent documents, visit www.u-blox.com.

Copyright © u-blox AG.

Contents

Document Information	2
Contents	3
1 Functional description	5
1.1 Overview	5
1.2 Product features	5
1.3 Performance.....	6
1.4 Block diagram	7
1.5 Supported GNSS Constellations	7
1.5.1 GPS	8
1.5.2 GLONASS	8
1.5.3 BeiDou	8
1.5.4 Galileo	8
1.6 Assisted GNSS (A-GNSS).....	8
1.6.1 AssistNow™ Online.....	8
1.6.2 AssistNow™ Offline.....	8
1.6.3 AssistNow™ Autonomous	9
1.7 Augmentation Systems	9
1.7.1 Satellite-Based Augmentation System (SBAS)	9
1.7.2 QZSS	9
1.7.3 QZSS L1S SLAS.....	9
1.7.4 IMES	9
1.7.5 Differential GPS (D-GPS).....	10
1.8 Broadcast Navigation Data	10
1.9 Untethered Dead Reckoning (UDR).....	10
1.10 Odometer	11
1.11 Data logging	11
1.12 Geofencing.....	11
1.13 Message Integrity Protection.....	11
1.14 Spoofing Detection	11
1.15 TIMEPULSE	11
1.16 Protocols and interfaces	12
1.17 Interfaces.....	12
1.17.1 UART	12
1.17.2 USB	12
1.17.3 SPI	12
1.17.4 Display Data Channel (DDC)	12
1.18 Clock generation.....	12
1.18.1 Oscillators	12
1.18.2 Real-Time Clock (RTC) and Hardware Backup mode	13
1.19 Power management	13

1.19.1 Power control.....	13
1.20 Antenna.....	13
2 Pin Definition.....	14
2.1 Pin assignment.....	14
2.2 Pin name changes.....	15
3 Configuration management.....	16
3.1 Interface Selection (D_SEL).....	16
4 Electrical specification	17
4.1 Absolute maximum rating.....	17
4.2 Operating conditions.....	18
4.3 Indicative current requirements	18
4.4 SPI timing diagrams	19
4.4.1 Timing recommendations.....	19
4.5 DDC timing diagrams	19
5 Mechanical specifications	20
6 Reliability tests and approvals.....	21
6.1 Reliability tests.....	21
6.2 Approvals.....	21
7 Product handling & soldering.....	22
7.1 Packaging	22
7.1.1 Reels.....	22
7.1.2 Tapes.....	22
7.2 Shipment, storage and handling	22
7.2.1 Moisture Sensitivity Levels	23
7.2.2 Reflow soldering.....	23
7.2.3 ESD handling precautions	23
8 Default messages	24
9 Labeling and ordering information	25
9.1 Product labeling.....	25
9.2 Explanation of codes	25
9.3 Ordering codes.....	25
Related documents	26
Revision history	26
Contact.....	27

1 Functional description

For more information about the functions, see the u-blox 8 / u-blox M8 Receiver Description Including Protocol Specification **Error! Reference source not found..**

1.1 Overview

The NEO-M8U module introduces u-blox’s Untethered Dead Reckoning (UDR) technology, which provides continuous navigation without requiring speed information from the vehicle. This innovative technology brings the benefits of dead reckoning to installations previously restricted to using GNSS alone, and significantly reduces the cost of installation for after-market dead reckoning applications.

The strength of UDR is particularly apparent under poor signal conditions, where it brings continuous positioning in urban environments, even to devices with antennas installed within the vehicle. Useful positioning performance is also available during complete signal loss, for example in parking garages and short tunnels. With UDR, positioning starts as soon as power is applied to the module, before the first GNSS fix is available.

The NEO-M8U may be installed in any position within the vehicle without configuration. In addition to its freedom from any electrical connection to the vehicle, the on-board accelerometer and gyroscope sensors result in a fully self-contained solution, perfect for rapid product development with reliable and consistent performance.

The intelligent combination of GNSS and sensor measurements enables accurate, real-time positioning at rates up to 30 Hz, as is needed for smooth and responsive interactive applications. Native high rate sensor data is made available to host applications such as driving behaviour analysis or accident reconstruction.

The NEO-M8U includes u-blox’s latest generation GNSS receiver, which adds Galileo to the multi-constellation reception that already includes GPS, GLONASS, BeiDou and QZSS. The module provides high sensitivity and fast GNSS signal acquisition and tracking. UART, USB, DDC (I2C compliant) and SPI interface options provide flexible connectivity and enable simple integration with most u-blox cellular modules.

U-blox M8 modules use GNSS chips qualified according to AEC-Q100 and are manufactured in ISO/TS 16949 certified sites. Qualification tests are performed as stipulated in the ISO16750 standard: “Road vehicles – Environmental conditions and testing for electrical and electronic equipment”.

1.2 Product features

Model	Category	GNSS	Supply	Interfaces	Features	Grade
	Standard Precision GNSS High Precision GNSS Dead Reckoning Timing	GPS/QZSS GLONASS Galileo BeiDou Number of concurrent GNSS	2.7 V – 3.6 V	UART USB SPI DDC (I ² C compliant)	Programmable (flash) Data logging Additional SAW Additional LNA RTC crystal Oscillator Built-in sensor Timepulse	Standard Professional Automotive
NEO-M8U	UDR	• • • •	•	• • • •	• • • • •	•

UDR = Untethered Dead Reckoning / C = Crystal

1.3 Performance

Parameter	Specification					
Receiver type	72-channel u-blox M8 engine GPS L1C/A, SBAS L1C/A, QZSS L1C/A, QZSS L1-SAIF, GLONASS L1OF, BeiDou B11 , Galileo E1B/C					
Accuracy of time pulse signal	RMS	30 ns				
	99%	60 ns				
Frequency of time pulse signal	0.25 Hz...10 MHz (configurable)					
Operational limits ¹	Dynamics	≤ 4 g				
	Altitude	50,000 m				
	Velocity	500 m/s				
Velocity accuracy ²	0.5 m/s.					
Heading accuracy ²	1 degrees					
Position error during GNSS loss ³	< 60 s signal loss	typ. 10% distance travelled				
Max navigation update rate, High Navigation Rate output	30 Hz					
Max navigation update rate (PVT) ⁴	2 Hz					
Navigation latency High Navigation Rate output	<10 ms					
Max sensor measurement output rate	100 Hz					
GNSS	GPS & GLONASS	GPS	GLONASS	BeiDou	Galileo	
Time-To-First-Fix ⁵	Cold start	26 s	30 s	31 s	39 s	57 s
	Hot start	1.5 s	1.5 s	1.5 s	1.5 s	1.5 s
	Aided starts ⁶	3 s	3 s	3 s	7 s	7 s
Sensitivity ⁷	Tracking & Navigation	-160 dBm	-160 dBm	-160 dBm	-160 dBm	-154 dBm
	Reacquisition	-160 dBm	-159 dBm	-156dBm	-155 dBm	-152 dBm
	Cold start	-148 dBm	-147 dBm	-145 dBm	-143 dBm	-133 dBm
	Hot start	-157 dBm	-156 dBm	-155 dBm	-155 dBm	-151 dBm
Horizontal position accuracy	Autonomous ⁸	2.5 m	2.5 m	4.0 m	3.0 m	TBC ⁹
	With SBAS ¹⁰	1.5 m	1.5 m	-	-	-
Altitude accuracy	With SBAS ¹¹	3.5 m	3.0 m	7.0 m	5.0 m	-

Table 1: NEO-M8U performance in different GNSS modes (default: concurrent reception of GPS and GLONASS)

¹ Configured for Airborne < 4g platform

² 50% @ 30 m/s

³ Typical error incurred without GNSS as a percentage of distance travelled

⁴ Rates with SBAS and QZSS enabled for > 98% fix report rate under typical conditions

⁵ All satellites at -130 dBm, except Galileo at -127 dBm

⁶ Dependent on aiding data connection speed and latency

⁷ Demonstrated with a good external LNA

⁸ CEP, 50%, 24 hours static, -130 dBm, > 6 SVs

⁹ To be confirmed when Galileo reaches full operational capability

¹⁰ CEP, 50%, 24 hours static, -130 dBm, > 6 SVs

¹¹ CEP, 50%, 24 hours static, -130 dBm, > 6 SVs

1.4 Block diagram

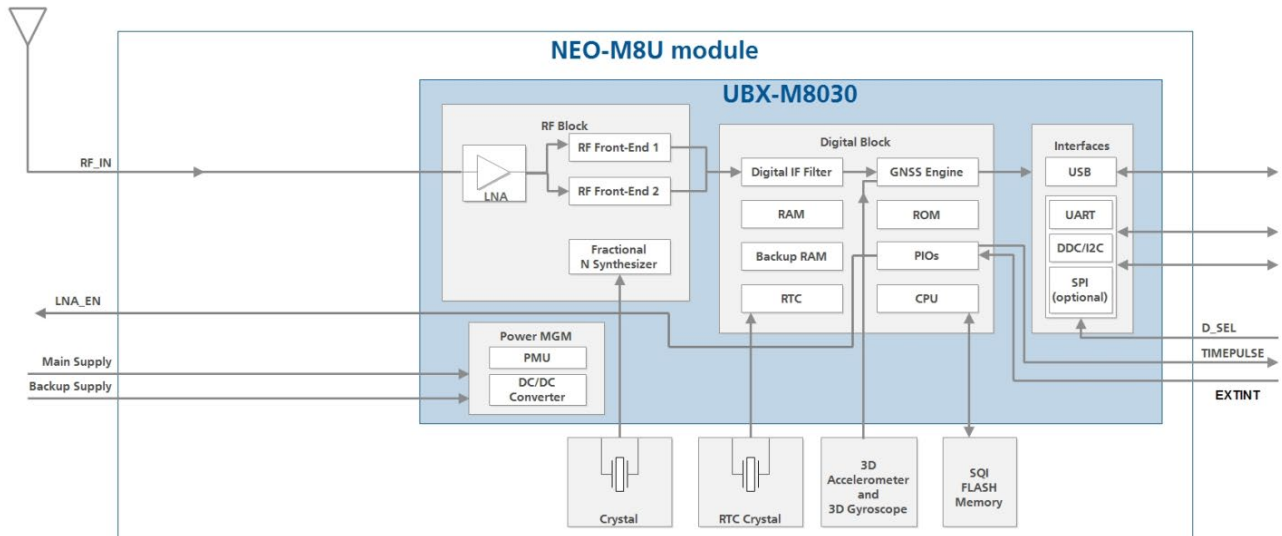

Figure 1: NEO-M8U block diagram

1.5 Supported GNSS Constellations

The NEO-M8U GNSS module is a concurrent GNSS receiver which can receive and track multiple GNSS systems: GPS, Galileo, GLONASS and BeiDou. Owing to the dual-frequency RF front-end architecture, either GLONASS or BeiDou can be processed concurrently with GPS and Galileo signals providing reception of three GNSS systems. By default the M8 receivers are configured for concurrent GPS and GLONASS, including SBAS and QZSS reception. If power consumption is a key factor, then the receiver should be configured for a single GNSS operation using GPS, Galileo, GLONASS or BeiDou and disabling QZSS and SBAS.

QZSS, IMES and SBAS augmentation systems share the same frequency band as GPS and can always be processed in conjunction with GPS.

The module can be configured to receive any single GNSS constellation or within the set of permissible combinations shown below.

GPS	Galileo	GLONASS	BeiDou
•	•	–	–
•	•	•	–
•	•	–	•
•	–	•	–
•	–	–	•
–	•	•	–
–	•	–	•
–	–	•	•

Table 2 Permissible GNSS combinations (• = enabled)

- The augmentation systems: SBAS and QZSS can be enabled only if GPS operation is configured.
- Galileo is not enabled as the default configuration.

1.5.1 GPS

The NEO-M8U positioning module is designed to receive and track the L1C/A signals provided at 1575.42 MHz by the Global Positioning System (GPS). The NEO-M8U can receive and process GPS concurrently with Galileo and one of GLONASS or BeiDou.

1.5.2 GLONASS



The NEO-M8U positioning module can receive and process GLONASS concurrently with GPS and Galileo together or BeiDou. The Russian GLONASS satellite system is a fully deployed alternative to the US-based Global Positioning System (GPS). The NEO-M8U module is designed to receive and track the L1OF signals GLONASS provides around 1602 MHz. The ability to receive and track GLONASS L1OF satellite signals allows design of GLONASS receivers where required by regulations.

1.5.3 BeiDou

The NEO-M8U positioning module can receive and process BeiDou concurrently with GPS and Galileo together or GLONASS. The NEO-M8U module is designed to receive and track the B1 signals provided at 1561.098 MHz by the BeiDou Navigation Satellite System. The ability to receive and track BeiDou B1 satellite signals in conjunction with GPS results in higher coverage, improved reliability and better accuracy. Global coverage is scheduled for 2020.

1.5.4 Galileo

The NEO-M8U positioning module can receive and track the E1-B/C signals centered on the GPS L1 frequency band. GPS and Galileo signals can be processed concurrently together with either BeiDou or GLONASS signals, enhancing coverage, reliability and accuracy. The SAR return link message (RLM) parameters for both short and long versions are decoded by the receiver and made available to users via UBX proprietary messages.

-  Galileo has been implemented according to ICD release 1.2 (November 2015) and verified with live signals from the Galileo in-orbit validation campaign. Since the Galileo satellite system has not yet reached Initial (IOC) nor Full Operational Capability (FOC), changes to the Galileo signal specification (OS SIS ICD) remain theoretically possible.
-  Galileo reception is by default disabled, but can be enabled by sending a configuration message (UBX-CFG-GNSS) to the receiver.

1.6 Assisted GNSS (A-GNSS)

Supply of aiding information, such as ephemeris, almanac, approximate position and time, will reduce the time to first fix significantly and improve the acquisition sensitivity. The NEO-M8U product supports the u-blox AssistNow Online and AssistNow Offline A-GNSS services, supports AssistNow Autonomous, and is OMA SUPL compliant.

1.6.1 AssistNow™ Online

With AssistNow Online, an internet-connected GNSS device downloads assistance data from u-blox's AssistNow Online Service at system start-up. AssistNow Online is network-operator independent and globally available. Devices can be configured to request only ephemeris data for those satellites currently visible at their location, thus minimizing the amount of data transferred.

1.6.2 AssistNow™ Offline

With AssistNow Offline, users download u-blox's long-term orbit data from the Internet at their convenience. The orbit data can be stored in the NEO-M8U GNSS receiver's SQL flash memory. Thus the service requires no connectivity at system start-up, enabling a position fix within seconds, even when no network is available. AssistNow Offline offers augmentation for up to 35 days.

1.6.3 AssistNow™ Autonomous

AssistNow Autonomous provides aiding information without the need for a host or external network connection. Based on previous broadcast satellite ephemeris data downloaded to and stored by the GNSS receiver, AssistNow Autonomous automatically generates accurate satellite orbital data (“AssistNow Autonomous data”) that is usable for future GNSS position fixes. The concept capitalizes on the periodic nature of GNSS satellites: their position in the sky is basically repeated every 24 hours. By capturing strategic ephemeris data at specific times over several days, the receiver can predict accurate satellite ephemeris for up to six days after initial reception.

u-blox’s AssistNow Autonomous benefits are:

- Faster fix in situations where GNSS satellite signals are weak
- No connectivity required
- Compatible with AssistNow Online and Offline (can work stand-alone, or in tandem with these services)
- No integration effort; calculations are done in the background, transparent to the user.

 For more details see the u-blox 8 / u-blox M8 Receiver Description Including Protocol Specification **Error! Reference source not found.** and the MGA Services User Guide **Error! Reference source not found.**

1.7 Augmentation Systems

1.7.1 Satellite-Based Augmentation System (SBAS)

The NEO-M8U positioning module supports SBAS. These systems supplement GPS data with additional GPS augmentation data within defined service areas. The systems broadcast augmentation data via satellite and this information can be used by GNSS receivers to improve the resulting precision. In some cases SBAS satellites can be used as additional satellites for ranging (navigation), further enhancing precision and availability.

1.7.2 QZSS

The Quasi-Zenith Satellite System (QZSS) is a regional navigation satellite system that transmits additional GPS L1 C/A signals for the Pacific region covering Japan and Australia. NEO-M8N positioning module is able to receive and track these signals concurrently with GPS signals, resulting in better availability especially under challenging signal conditions, e.g. in urban canyons.

1.7.3 QZSS L1S SLAS

QZSS SLAS (Sub-meter Level Augmentation Service) is an augmentation technology, which provides correction data for pseudoranges of GPS and QZSS satellites. With the QZSS SLAS enabled, u-blox receivers autonomously select the most suitable Ground monitoring stations (GMS) based on the user’s location. The correction stream of this GMS will then be applied to the measurements in order to improve the position accuracy.

1.7.4 IMES

The Japanese Indoor MESSaging System (IMES) system is used for indoor position reporting using low-power transmitters which broadcast a GPS-like signal. NEO-M8N module can be configured to receive and demodulate the signal to provide an in-door location estimate.

 This service is authorized and available only in Japan.

 IMES reception is disabled by default.

1.7.5 Differential GPS (D-GPS)

The use of Differential-GPS data improves GPS position accuracy using real time data from a nearby reference receiver or network. The NEO-M8U receiver supports D-GPS only with Dead Reckoning disabled (using message UBX-CFG-NAVX5). D-GPS starts on receipt of valid data according to RTCM 10402.3: "RECOMMENDED STANDARDS FOR DIFFERENTIAL GNSS". RTCM cannot be used together with SBAS or Dead Reckoning and is applicable only to GPS signals in the NEO-M8U. The RTCM implementation supports the following RTCM 2.3 messages:

Message Type	Description
1	Differential GPS Corrections
2	Delta Differential GPS Corrections
3	GPS Reference Station Parameters
9	GPS Partial Correction Set

Table 3: Supported RTCM 2.3 messages

1.8 Broadcast Navigation Data

The NEO-M8U can output all the GNSS broadcast data upon reception from tracked satellites. This includes all the supported GNSS signals plus the augmentation services SBAS, QZSS and IMES.

The L1- SAIF signal provided by QZSS can be enabled for reception via a GNSS configuration message.

1.9 Untethered Dead Reckoning (UDR)

u-blox's proprietary Untethered Dead Reckoning (UDR) solution uses an inertial measurement unit (IMU) included within the module. IMU data and GNSS signals are processed together, achieving accurate and continuous positioning in GNSS-hostile environments (e.g. urban canyons) and useful positioning even in case of complete GNSS signal absence (e.g. tunnels and parking garages).

The NEO-M8U combines GNSS and IMU measurements and calculates position solutions at rates of up to 2 Hz. These solutions are reported in standard NMEA, UBX-NAV-PVT and related messages. A new High Navigation Rate output message (UBX-HNR-PVT) extends these results with IMU-only data to deliver accurate, low latency position solutions at rates up to 30 Hz.

Dead reckoning allows navigation to commence as soon as power is applied to the module (i.e. before a GNSS fix has been established) and given all of the following conditions:

- the vehicle has not been moved without power applied to the module
- at least a dead-reckoning fix was available when the vehicle was last used
- a back-up supply has been available for the module since the vehicle was last used

For post-processing applications sensor data is available from messages UBX-ESF-MEAS and UBX-ESF-RAW (high rate). Each message includes the time of measurement.

1.10 Odometer

The odometer provides information on travelled ground distance (in meter) using position and velocity measurements from the combined GNSS/DR navigation solution. For each computed travelled distance since the last odometer reset, the odometer estimates a 1-sigma accuracy value. The total cumulative ground distance is maintained and saved in the BBR memory.

 The odometer feature is disabled by default.

1.11 Data logging

The u-blox NEO-M8U receiver can be used in data logging applications. The data logging feature enables continuous storage of position, velocity and time information to an onboard SQL flash memory. It can also log the distance reported by the odometer. The information can be downloaded from the receiver later for further analysis or for conversion to a mapping tool.

1.12 Geofencing

The u-blox NEO-M8U module supports up to four circular geofencing areas defined on the Earth's surface using a 2D model. Geofencing is active when at least one geofence is defined, the current status can be found by polling the receiver. A GPIO pin can be nominated to indicate status to e.g. wake up a host on activation.

1.13 Message Integrity Protection

The NEO-M8U provides a function to detect third party interference with the UBX message stream sent from receiver to host. The security mechanism “signs” nominated messages via a subsequent UBX message. This message signature is then compared with a signature generated by the host to determine if the message data has been altered.

1.14 Spoofing Detection

Spoofing is when a malicious third party tries to control the reported position via a fake GNSS broadcast signal. This may result in reporting incorrect position, velocity or time. To combat this, the NEO-M8U module includes spoofing detection measures to alert the host when signals appear to be suspicious. The receiver combines a number of checks on the received signals looking for inconsistencies across several parameters.

1.15 TIMEPULSE

A configurable time pulse signal is available with the NEO-M8U module.

The TIMEPULSE output generates pulse trains synchronized with GPS or UTC time grid with intervals configurable over a wide frequency range. Thus it may be used as a low frequency time synchronization pulse or as a high frequency reference signal.

 The NEO-M8U time-pulse output is configured using messages for “TIMEPULSE2.” This pin has a secondary function during start-up (initiation of “SAFEBOOT” mode for firmware recovery) and should not normally be held LOW during start-up.

By default the time pulse signal is disabled.

1.16 Protocols and interfaces

Protocol	Type
NMEA 0183 V4.0 (V2.1, V2.3 and V4.1 configurable)	Input/output, ASCII
UBX	Input/output, binary, u-blox proprietary
RTCM	Input, messages 1, 2, 3, 9

Table 4: Available Protocols

All protocols are available on UART, USB, DDC (I²C compliant) and SPI. For specification of the various protocols see the *u-blox 8 / u-blox M8 Receiver Description Including Protocol Specification* **Error! Reference source not found..**

1.17 Interfaces

A number of interfaces are provided for data communication. The embedded firmware uses these interfaces according to their respective protocol specifications.

1.17.1 UART

The NEO-M8U module includes one UART interface, which can be used for communication to a host. It supports configurable baud rates. For supported baud rates see the *u-blox 8 / u-blox M8 Receiver Description Including Protocol Specification* **Error! Reference source not found..**

 Designs must allow access to the UART and the **SAFEBOOT_N** function pin for future service, updates and reconfiguration.

1.17.2 USB

A USB interface, which is compatible to USB version 2.0 FS (Full Speed, 12 Mbit/s), can be used for communication as an alternative to the UART. The pull-up resistor on pin **USB_DP** is integrated to signal a full-speed device to the host. The **VDD_USB** pin supplies the USB interface. The u-blox USB (CDC-ACM) driver supports Windows Vista plus Windows 7 and 8 operating systems. A separate driver (CDC-ACM) is not required for Windows 10 which has a built-in USB-serial driver. However, plugging initially into an internet connected Windows 10 PC, will down-load the u-blox combined sensor and VCP driver package.

USB drivers can be down-loaded from the u-blox web site, www.u-blox.com.

1.17.3 SPI

The SPI interface is designed to allow communication to a host CPU. The interface can be operated in slave mode only. The maximum transfer rate using SPI is 125 kB/s and the maximum SPI clock frequency is 5.5 MHz, see Figure 3. Note that SPI is not available in the default configuration, because its pins are shared with the UART and DDC interfaces. The SPI interface can be enabled by connecting **D_SEL** (Pin 2) to ground (see section 3.1).

1.17.4 Display Data Channel (DDC)

An I²C compliant DDC interface is available for communication with an external host CPU or u-blox cellular modules. The interface can be operated in slave mode only. The DDC protocol and electrical interface are fully compatible with Fast-Mode of the I²C industry standard. Since the maximum SCL clock frequency is 400 kHz, the maximum transfer rate is 400 kb/s.

1.18 Clock generation

1.18.1 Oscillators

The NEO-M8U GNSS module uses a crystal-based oscillator.

1.18.2 Real-Time Clock (RTC) and Hardware Backup mode

The RTC can be maintained by a secondary 32 kHz oscillator using an RTC crystal. If the main supply voltage is removed, a battery connected to **V_BCKP** allows the RTC to continue to run with very low power consumption. The same supply also maintains a static back-up memory for current configuration information, recent ephemeris, location and auxiliary data necessary to ensure the fastest re-acquisition when the primary power supply is restored.

 Dead-reckoning before the first GNSS fix requires that the RTC has been enabled and powered since the previous fix.

1.19 Power management

u-blox M8 technology offers a power-optimized architecture with built-in autonomous power saving functions to minimize power consumption at any given time. In addition, a high efficiency DC/DC converter is integrated for lower power consumption and reduced dissipation.

1.19.1 Power control

A separate battery backup voltage may be applied to the module to retain the current state of the receiver and sustain a low power real time clock (RTC) while the main supply is removed. This enables fast acquisition and navigation based on dead-reckoning before the first GNSS-based fix.

Alternatively, a configuration command (UBX-CFG-PWR) can be issued to stop the receiver in a similar way to Hardware Backup Mode (see section 1.18.2) while the main supply remains active. This mode is referred to as Software backup mode; current consumption in this mode is slightly higher than in Hardware Backup Mode. The receiver will then restart on the next edge received at its UART interface (there will be a delay before any communications are possible).

See Table 10 for current consumption in backup mode.

1.20 Antenna

u-blox recommend use of an active antenna¹² or external LNA with this module to achieve best performance.

Parameter	Specification	
Antenna Type	Active or passive antenna	
Active Antenna Recommendations	Minimum gain	15 dB (to compensate signal loss in RF cable)
	Maximum gain	50 dB ¹³
	Maximum noise figure	1.5 dB

Table 5: Antenna Specifications for the NEO-M8U module

The antenna system should include filtering to ensure adequate protection from nearby transmitters. Care should be taken in the selection of antennas placed closed to cellular or Wi-Fi transmitting antennas.

 For guidance on antenna selection see the NEO-M8U Hardware Integration Manual [1].

¹² For information on using active antennas with NEO-M8U modules, see the *NEO-M8U Hardware Integration Manual* [1].

¹³ Gain above 20 dB should be avoided unless interference in the band 1463 MHz to 1710 MHz is adequately controlled.

2 Pin Definition

2.1 Pin assignment

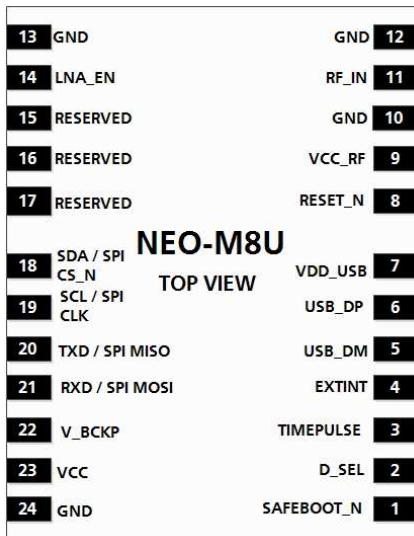



Figure 2: Pin Assignment

No	Name	I/O	Description
1	SAFEBOOT_N	I	SAFEBOOT_N, Test-point for service use (Leave OPEN)
2	D_SEL	I	Interface select
3	TIMEPULSE	I/O	Time pulse (disabled by default), do not pull low during reset Note: configured using TIMEPULSE2 messages (see section 1.15)
4	EXTINT	I	External Interrupt Pin
5	USB_DM	I/O	USB Data
6	USB_DP	I/O	USB Data
7	VDD_USB	I	USB Supply
8	RESET_N	I	RESET_N
9	VCC_RF	O	Output Voltage RF section
10	GND	I	Ground
11	RF_IN	I	GNSS signal input
12	GND	I	Ground
13	GND	I	Ground
14	LNA_EN	O	Antenna control
15	Reserved	-	Reserved
16	Reserved	-	Reserved
17	Reserved	-	Reserved
18	SDA / SPI CS_N	I/O	DDC Data if D_SEL = 1 (or open) / SPI Chip Select if D_SEL = 0
19	SCL / SPI CLK	I/O	DDC Clock if D_SEL = 1 (or open) / SPI Clock if D_SEL = 0
20	TXD / SPI MISO	O	Serial Port if D_SEL = 1 (or open) / SPI MISO if D_SEL = 0
21	RXD / SPI MOSI	I	Serial Port if D_SEL = 1 (or open) / SPI MOSI if D_SEL = 0
22	V_BCKP	I	Backup voltage supply
23	VCC	I	Supply voltage
24	GND	I	Ground

Table 6: Pinout of NEO-M8U

 Pins designated Reserved should not be used. For more information about Pinouts see the NEO-M8U Hardware Integration Manual **Error! Reference source not found..**

2.2 Pin name changes

Selected pin names have been updated to agree with a common naming convention across u-blox modules. The pins have not changed their operation and are the same physical hardware but with updated names. The table below lists the pins that have changed name along with their old and new names.

No	Previous Name	New name
14	ANT_ON	LNA_EN
20	TxD SPI MISO	TXD / SPI MISO
21	RxD SPI MOSI	RXD / SPI MOSI

Table 7: Pin name changes

3 Configuration management

Configuration settings can be modified with UBX configuration messages. The modified settings remain effective until power-down or reset. Settings can also be saved in battery-backed RAM, Flash or both using the UBX-CFG-CFG message. If settings have been stored in battery-backed RAM then the modified configuration will be retained as long as the backup battery supply is not interrupted. Settings stored in Flash memory will remain effective even after power-down and do not require backup battery supply.

3.1 Interface Selection (D_SEL)

At startup Pin 2 (**D_SEL**) determines which data interfaces are used for communication. If **D_SEL** is set high or left open, UART and DDC become available. If **D_SEL** is set low, i.e. connected to ground, the NEO-M8U module can communicate to a host via SPI.

PIN #	D_SEL="1" (left open)	D_SEL="0" (connected to GND)
20	UART TX	SPI MISO
21	UART RX	SPI MOSI
19	DDC SCL	SPI CLK
18	DDC SDA	SPI CS_N

Table 8: Data interface selection by D_SEL

4 Electrical specification

The limiting values given are in accordance with the Absolute Maximum Rating System (IEC 134). Stress above one or more of the limiting values may cause permanent damage to the device. These are stress ratings only and operation of the device at these or at any other conditions above those given in the characteristics sections of the specification is not implied. Exposure to these limits for extended periods may affect device reliability.

Where application information is given, it is advisory only and does not form part of the specification. For more information see the NEO-M8U Hardware Integration Manual **Error! Reference source not found..**

4.1 Absolute maximum rating

Parameter	Symbol	Condition	Min	Max	Units
Power supply voltage	VCC		-0.5	3.6	V
Backup battery voltage	V_BCKP		-0.5	3.6	V
USB supply voltage	VDD_USB		-0.5	3.6	V
Input pin applied DC voltage	Vin		-0.5	VCC+0.5	V
	Vin_usb		-0.5	VDD_USB	V
	Vrfin		0	6	V
DC current through any digital I/O pin (except supplies)	Ipin			10	mA
VCC_RF output current	ICC_RF			100	mA
Input power at RF_IN	Prfin	source impedance = 50 Ω, continuous wave		15	dBm
Storage temperature	Tstg		-40	85	°C

Table 9: Absolute maximum ratings

Stressing the device beyond the “Absolute Maximum Ratings” may cause permanent damage. These are stress ratings only. The product is not protected against overvoltage or reversed voltages. If necessary, voltage spikes exceeding the power supply voltage specification, given in table above, must be limited to values within the specified boundaries by using appropriate protection diodes.

4.2 Operating conditions

All specifications are at an ambient temperature of 25°C. Extreme operating temperatures can significantly impact specification values. Applications operating near the temperature limits should be tested to ensure the specification.

Parameter	Symbol	Min	Typical	Max	Units	Condition	
Power supply voltage	VCC	2.7	3.0	3.6	V		
Supply voltage USB	VDD_USB	3.0	3.3	3.6	V		
Backup battery voltage	V_BCKP	1.4		3.6	V		
Backup battery current	I_BCKP		15		μA	V_BCKP = 1.8 V, VCC = 0 V	
SW backup current	I_SWBCKP		30		μA	VCC = 3 V	
Input pin voltage range	Vin	0		VCC	V		
Digital IO Pin Low level input voltage	Vil	0		0.2*VCC	V		
Digital IO Pin High level input voltage	Vih	0.7*VCC		VCC	V		
Digital IO Pin Low level output voltage	Vol			0.4	V	Iol = 4 mA	
Digital IO Pin High level output voltage	Voh	VCC-0.4			V	Ioh = 4 mA	
Pull-up resistor for RESET_N	Rpu		11		kΩ		
USB_DM, USB_DP	VinU	Compatible with USB with 27 Ω series resistance					
VCC_RF voltage	VCC_RF		VCC-0.1		V		
VCC_RF output current	ICC_RF			50	mA		
Receiver Chain Noise Figure ¹⁴	NFtot		3		dB		
Operating temperature	Topr	-40		85	°C		

Table 10: Operating conditions

Operation beyond the specified operating conditions can affect device reliability.

4.3 Indicative current requirements

Table 11 lists examples of the total system supply current for a possible application.

Values in Table 11 are provided for customer information only as an example of typical power requirements. Values are characterized on samples, actual power requirements can vary depending on FW version used, external circuitry, number of SVs tracked, signal strength, type of start as well as time, duration and conditions of test.

Parameter	Symbol	Typ GPS & GLONASS	Typ GPS / QZSS / SBAS	Max	Units	Condition
Max. supply current ¹⁵	Iccp			67	mA	
Average supply current ^{16, 17}	Icc	29	23		mA	Estimated at 3 V

Table 11: Indicative power requirements at 3.0 V

For more power requirements information, see the NEO-M8U Hardware Integration Manual **Error! Reference source not found..**

¹⁴ Only valid for the GPS band

¹⁵ Use this figure to determine maximum current capability of power supply. Measurement of this parameter with 1 Hz bandwidth.

¹⁶ Acquisition and tracking use this figure to determine required battery capacity.

¹⁷ Simulated GNSS constellation using power levels of -130 dBm. VCC = 3.0 V

4.4 SPI timing diagrams

In order to avoid incorrect operation of the SPI, the user needs to comply with certain timing conditions. The following signals need to be considered for timing constraints:

Symbol	Description
SPI CS_N (SS_N)	Slave select signal
SPI CLK (SCK)	Slave clock signal

Table 12: Symbol description

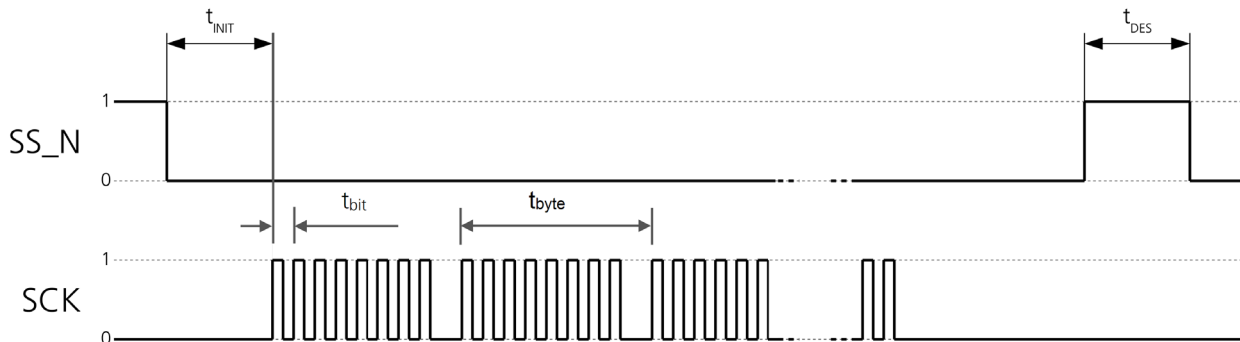

Figure 3: SPI timing diagram

4.4.1 Timing recommendations

The recommendations below are based on a firmware running from Flash memory.

Parameter	Description	Recommendation
t_{INIT}	Initialization Time	>10 μ s
t_{DES}	Deselect Time	1 ms.
t_{bit}	Minimum bit time	180 ns (5.5 MHz max bit frequency)
t_{byte}	Minimum byte period	8 μ s (125 kHz max byte frequency)

Table 13: SPI timing recommendations

- The values in the above table result from the requirement of an error-free transmission. By allowing just a few errors and disabling the glitch filter, the bit rate can be increased considerably.

4.5 DDC timing diagrams

The DDC interface is I²C Fast Mode compliant. For timing parameters consult the I²C standard.

- The maximum bit rate is 400 kb/s. The interface stretches the clock when slowed down when serving interrupts, so real bit rates may be slightly lower.

5 Mechanical specifications

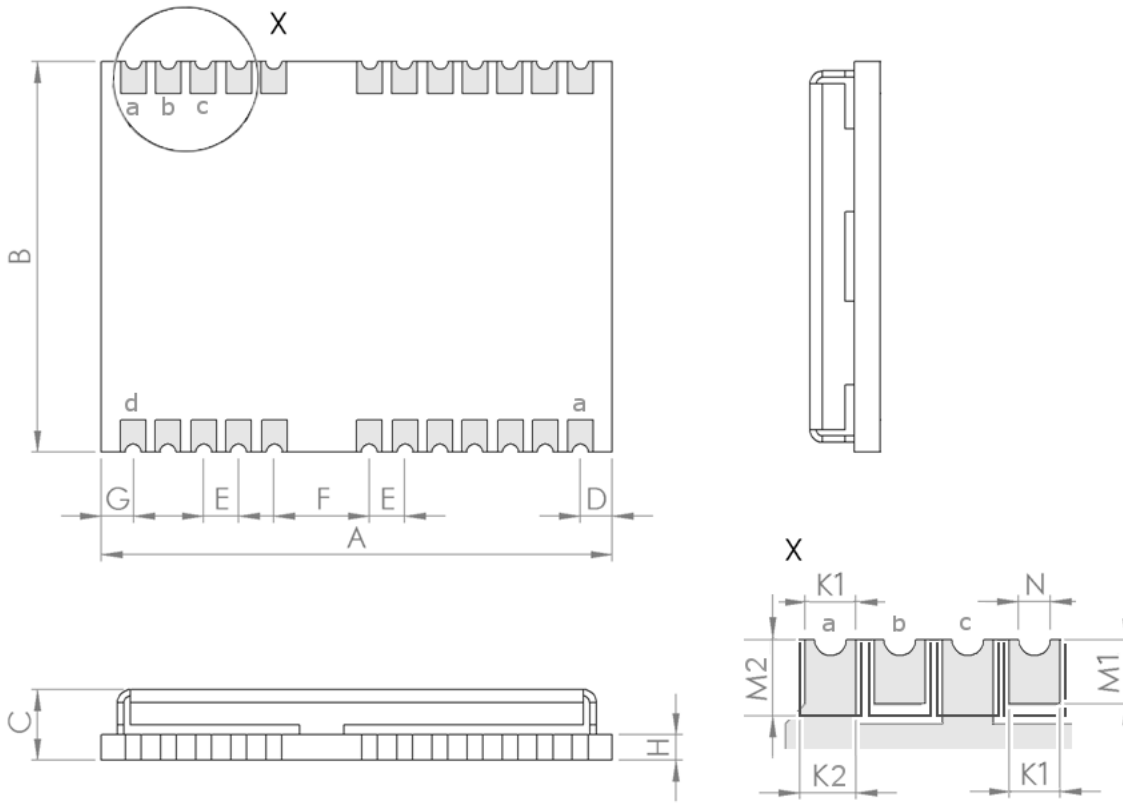

Symbol	Description	Min. (mm)	Typ. (mm)	Max. (mm)
A	Module height	15.9	16.0	16.6
B	Module width	12.1	12.2	12.3
C	Module total thickness	2.2	2.4	2.6
D, G	Horizontal edge to pin pitch	0.9	1.0	1.3
E	Pin to pin pitch	1.0	1.1	1.2
F	Gap width	2.9	3.0	3.1
H	Module PCB thickness		0.82	
K1	Pad width (metal)	0.7	0.8	0.9
K2	Pad width (metal / solder mask)	0.7	0.8 / 0.9	0.9 / 1.2
M1	Pad height (metal)	0.7	0.8	0.9
M2	Pad height (solder mask)	0.7	0.9	1.1
N	Pad half-moon diameter	0.4	0.5	0.6
	Module weight (g)		1.6	

Figure 4: Dimensions

For information about the paste mask and footprint, see the NEO-M8U Hardware Integration Manual **Error! Reference source not found..**

6 Reliability tests and approvals

6.1 Reliability tests

 The NEO-M8U module is based on AEC-Q100 qualified GNSS chips.

Tests for product family qualifications are according to ISO 16750 "Road vehicles – environmental conditions and testing for electrical and electronic equipment", and appropriate standards.

6.2 Approvals



Products marked with this lead-free symbol on the product label comply with the "Directive 2002/95/EC and Directive 2011/65/EU of the European Parliament and the Council on the Restriction of Use of certain Hazardous Substances in Electrical and Electronic Equipment" (RoHS).

All u-blox M8 GNSS modules are RoHS compliant.

7 Product handling & soldering

7.1 Packaging

The NEO-M8U GNSS modules are delivered as hermetically sealed, reeled tapes in order to enable efficient production, production lot set-up and tear-down. For more information see the *u-blox Package Information Guide* **Error! Reference source not found..**

7.1.1 Reels

The NEO-M8U GNSS modules are deliverable in quantities of 250 pcs on a reel. The NEO-M8U receivers are shipped on Reel Type B, as specified in the *u-blox Package Information Guide* **Error! Reference source not found..Error! Reference source not found..**

7.1.2 Tapes

The dimensions and orientations of the tapes for NEO-M8U GNSS modules are specified in Figure 5.

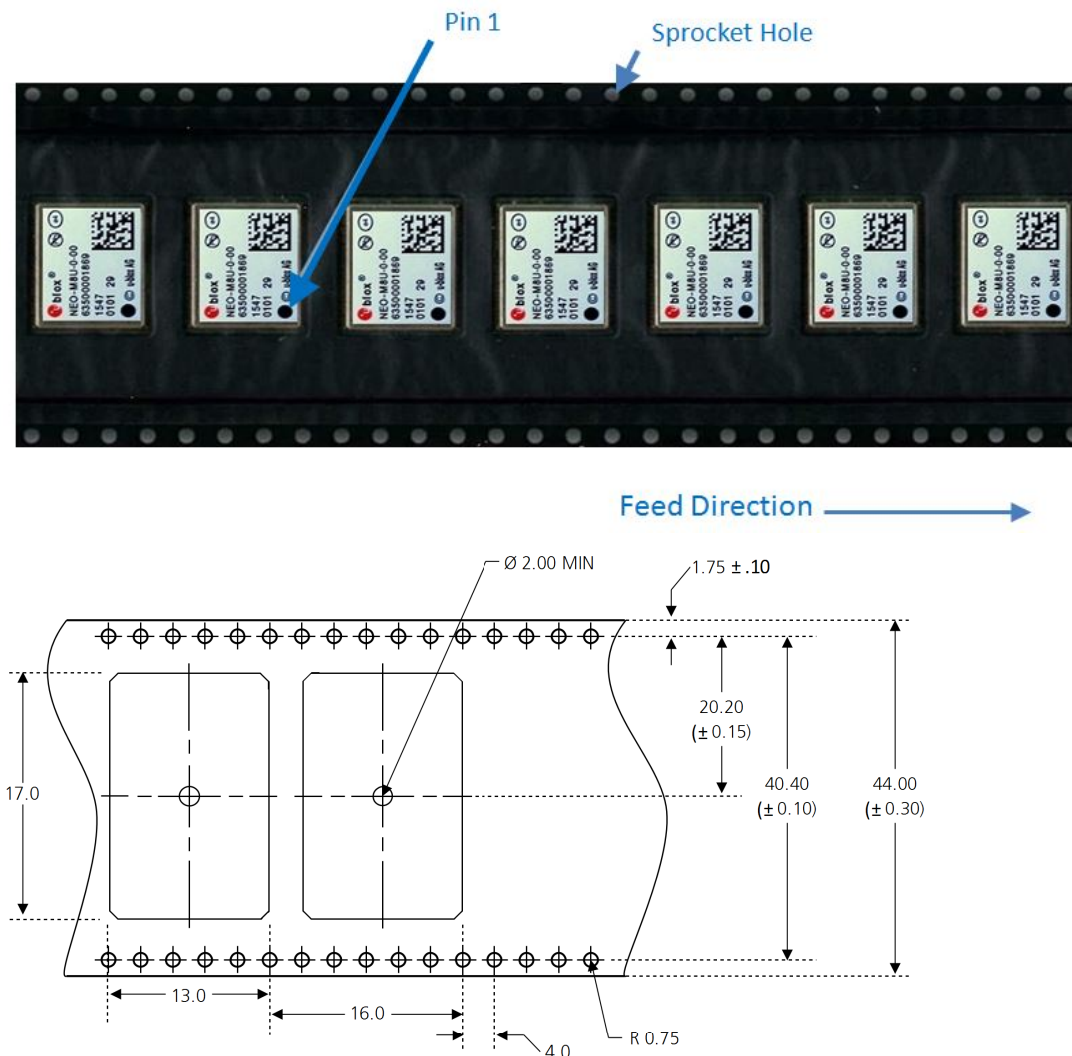



Figure 5: Dimensions and orientation for NEO-M8U modules on tape

7.2 Shipment, storage and handling

For important information regarding shipment, storage and handling see the *u-blox Package Information Guide* **Error! Reference source not found..**

7.2.1 Moisture Sensitivity Levels

The Moisture Sensitivity Level (MSL) relates to the packaging and handling precautions required. The NEO-M8U modules are rated at MSL level 4.

-  For MSL standard see IPC/JEDEC J-STD-020, which can be downloaded from www.jedec.org.
-  For more information regarding MSL see the u-blox Package Information Guide **Error! Reference source not found..**

7.2.2 Reflow soldering

Reflow profiles are to be selected according u-blox recommendations (see the *NEO-M8U Hardware Integration Manual* **Error! Reference source not found.**).

7.2.3 ESD handling precautions

-  NEO-M8U modules are Electrostatic Sensitive Devices (ESD). Observe precautions for handling! Failure to observe these precautions can result in severe damage to the GNSS receiver!

GNSS receivers are Electrostatic Sensitive Devices (ESD) and require special precautions when handling. Particular care must be exercised when handling patch antennas, due to the risk of electrostatic charges. In addition to standard ESD safety practices, the following measures should be taken into account whenever handling the receiver:

- Unless there is a galvanic coupling between the local GND (i.e. the work table) and the PCB GND, then the first point of contact when handling the PCB must always be between the local GND and PCB GND.
- Before mounting an antenna patch, connect ground of the device
- When handling the RF pin, do not come into contact with any charged capacitors and be careful when contacting materials that can develop charges (e.g. patch antenna ~10 pF, coax cable ~50-80 pF/m, soldering iron, ...)
- To prevent electrostatic discharge through the RF input, do not touch any exposed antenna area. If there is any risk that such exposed antenna area is touched in non ESD protected work area, implement proper ESD protection measures in the design.
- When soldering RF connectors and patch antennas to the receiver's RF pin, make sure to use an ESD safe soldering iron (tip).

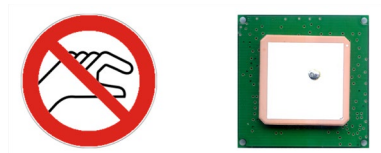

8 Default messages

Interface	Settings
UART Output	9600 Baud, 8 bits, no parity bit, 1 stop bit Configured to transmit both NMEA and UBX protocols, but only the following NMEA (and no UBX) messages have been activated at start-up: GGA, GLL, GSA, GSV, RMC, VTG, TXT
USB Output	Configured to transmit both NMEA and UBX protocols, but only the following NMEA (and no UBX) messages have been activated at start-up: GGA, GLL, GSA, GSV, RMC, VTG, TXT USB Power Mode: Bus Powered
UART Input	9600 Baud, 8 bits, no parity bit, 1 stop bit, Autobauding disabled Automatically accepts following protocols without need of explicit configuration: UBX, NMEA, RTCM The GNSS receiver supports interleaved UBX and NMEA messages.
USB Input	Automatically accepts following protocols without need of explicit configuration: UBX, NMEA The GPS receiver supports interleaved UBX and NMEA messages. USB Power Mode: Bus Powered
DDC	Fully compatible with the I ² C industry standard, available for communication with an external host CPU or u-blox cellular modules, operated in slave mode only. Default messages activated. NMEA and UBX are enabled as input messages, only NMEA as output messages. Maximum bit rate 400 kb/s.
SPI	Allow communication to a host CPU, operated in slave mode only. Default messages activated. SPI is not available in the default configuration.
TIMEPULSE	disabled

Table 14: Default messages

 Refer to the u-blox 8 / u-blox M8 Receiver Description Including Protocol Specification **Error! Reference source not found.** for information about further settings.

9 Labeling and ordering information

9.1 Product labeling

The labeling of u-blox M8 GNSS modules includes important product information. The location of the NEO-M8U product type number is shown in Figure 6.

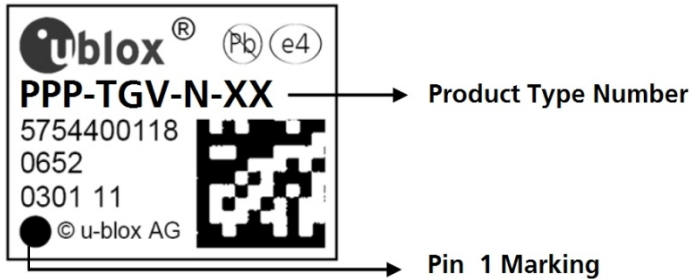

Figure 6: Location of product type number on the u-blox NEO-M8U module label

9.2 Explanation of codes

Three different product code formats are used. The **Product Name** is used in documentation such as this data sheet and identifies all u-blox M8 products, independent of packaging and quality grade. The **Ordering Code** includes options and quality, while the **Type Number** includes the hardware and firmware versions. Table 15 shows the structure of these three different formats.

Format	Structure
Product Name	PPP-TGV
Ordering Code	PPP-TGV-N
Type Number	PPP-TGV-N-XX

Table 15: Product Code Formats

The parts of the product code are explained in Table 16.

Code	Meaning	Example
PPP	Product Family	NEO
TG	Platform	M8 = u-blox M8
V	Variant	Function set (A-Z), T = Timing, R = DR, etc.
N	Option / Quality Grade	Describes standardized functional element or quality grade 0 = Default variant, A = Automotive
XX	Product Detail	Describes product details or options such as hard- and software revision, cable length, etc.

Table 16: part identification code

9.3 Ordering codes

Ordering No.	Product
NEO-M8U-04B	u-blox M8 GNSS LCC module Untethered Dead-Reckoning and on-board sensors, 12.2x16 mm, 250 pcs/reel

Table 17: Product ordering codes for NEO-M8U module

Product changes affecting form, fit or function are documented by u-blox. For a list of Product Change Notifications (PCNs) see our website.

Related documents

- [1] NEO-M8U Hardware Integration Manual, UBX-15016700
- [2] u-blox 8 / u-blox M8 Receiver Description including Protocol Specification, UBX 13003221
- [3] u-blox Package Information Guide, UBX-14001652
- [4] MGA Services User Guide, UBX-13004360

 For regular updates to u-blox documentation and to receive product change notifications, register on our homepage (www.u-blox.com).

Revision history

Revision	Date	Name	Comments
R01	17-Feb-2016	amil	Objective Specification
R02	01-Jun-2016	ghun/amil	Advance Information Updated Section 2 for Pin name changes, Section 4.1, Section 4.3, Section 4.4 SPI Timing, Figure 1, Figure 2, and Section 1.3.
R03	27-Jun-2016	njaf	Early Product Information
R04	20-Sep-2016	njaf	Production Information
R05	02-Oct-2018	pmcm, njaf	Changed the firmware version (page 2). Updated Mechanical specifications (section 5).
R06	15-Feb-2019	mawa	Changed ordering code to -04B

Contact

For complete contact information, visit us at www.u-blox.com.

u-blox Offices

North, Central and South America

u-blox America, Inc.

Phone: +1 703 483 3180
E-mail: info_us@u-blox.com

Regional Office West Coast:

Phone: +1 408 573 3640
E-mail: info_us@u-blox.com

Technical Support:

Phone: +1 703 483 3185
E-mail: support@u-blox.com

Headquarters

Europe, Middle East, Africa

u-blox AG

Phone: +41 44 722 74 44
E-mail: info@u-blox.com
Support: support@u-blox.com

Documentation Feedback

E-mail: docsupport@u-blox.com

Asia, Australia, Pacific

u-blox Singapore Pte. Ltd.

Phone: +65 6734 3811
E-mail: info_ap@u-blox.com
Support: support_ap@u-blox.com

Regional Office Australia:

Phone: +61 2 8448 2016
E-mail: info_anz@u-blox.com
Support: support_ap@u-blox.com

Regional Office China (Beijing):

Phone: +86 10 68 133 545
E-mail: info_cn@u-blox.com
Support: support_cn@u-blox.com

Regional Office China (Chongqing):

Phone: +86 23 6815 1588
E-mail: info_cn@u-blox.com
Support: support_cn@u-blox.com

Regional Office China (Shanghai):

Phone: +86 21 6090 4832
E-mail: info_cn@u-blox.com
Support: support_cn@u-blox.com

Regional Office China (Shenzhen):

Phone: +86 755 8627 1083
E-mail: info_cn@u-blox.com
Support: support_cn@u-blox.com

Regional Office India:

Phone: +91 80 405 092 00
E-mail: info_in@u-blox.com
Support: support_in@u-blox.com

Regional Office Japan (Osaka):

Phone: +81 6 6941 3660
E-mail: info_jp@u-blox.com
Support: support_jp@u-blox.com

Regional Office Japan (Tokyo):

Phone: +81 3 5775 3850
E-mail: info_jp@u-blox.com
Support: support_jp@u-blox.com

Regional Office Korea:

Phone: +82 2 542 0861
E-mail: info_kr@u-blox.com
Support: support_kr@u-blox.com

Regional Office Taiwan:

Phone: +886 2 2657 1090
E-mail: info_tw@u-blox.com
Support: support_tw@u-blox.com