



NEO-M9N

u-blox M9 standard precision GNSS module

Integration manual



Abstract

Integration manual describing the u-blox NEO-M9N GNSS module. NEO-M9N offers ultra-robust meter-level GNSS positioning performance with concurrent reception of up to four GNSS (GPS, GLONASS, BeiDou, Galileo) in a 12.2 x 16.0 mm package.

www.u-blox.com

UBX-19014286 - R01



Document information

Title	NEO-M9N		
Subtitle	u-blox M9 standard precision GNSS module		
Document type	Integration manual		
Document number	UBX-19014286		
Revision and date	R01		28-Nov-2019
Document status	Advance information		

This document applies to the following products:

Product name	Type number	Firmware version	PCN reference
NEO-M9N	NEO-M9N-00B-00	SPG 4.00	N/A

u-blox reserves all rights to this document and the information contained herein. Products, names, logos and designs described herein may in whole or in part be subject to intellectual property rights. Reproduction, use, modification or disclosure to third parties of this document or any part thereof without the express permission of u-blox is strictly prohibited.

The information contained herein is provided "as is" and u-blox assumes no liability for the use of the information. No warranty, either express or implied, is given with respect to, including but not limited to, the accuracy, correctness, reliability and fitness for a particular purpose of the information. This document may be revised by u-blox at any time. For most recent documents, please visit www.u-blox.com.

Copyright © 2019, u-blox AG.

u-blox is a registered trademark of u-blox Holding AG in the EU and other countries.

Contents

1 Integration manual structure.....	6
2 System description.....	7
2.1 Overview.....	7
2.2 Architecture.....	7
2.2.1 Block diagram.....	7
3 Receiver functionality.....	8
3.1 Receiver configuration.....	8
3.1.1 Changing the receiver configuration.....	8
3.1.2 Legacy configuration interface compatibility.....	8
3.1.3 Basic receiver configuration.....	8
3.1.4 Default GNSS configuration.....	10
3.1.5 Default interface settings.....	10
3.1.6 Navigation configuration.....	10
3.2 Geofencing.....	16
3.2.1 Introduction.....	16
3.2.2 Interface.....	16
3.2.3 Geofence state evaluation.....	16
3.2.4 Using a PIO for geofence state output.....	17
3.3 Logging.....	17
3.3.1 Introduction.....	17
3.3.2 Setting the logging system up.....	17
3.3.3 Information about the log.....	18
3.3.4 Recording.....	18
3.3.5 Retrieval.....	20
3.3.6 Command message acknowledgment.....	20
3.4 Data batching.....	21
3.4.1 Introduction.....	21
3.4.2 Setting up the data batching.....	21
3.4.3 Retrieval.....	22
3.5 Communication interfaces.....	22
3.5.1 UART interface.....	22
3.5.2 I2C interface.....	23
3.5.3 SPI interface.....	26
3.5.4 USB interface.....	27
3.6 Predefined PIOs.....	28
3.6.1 D_SEL.....	28
3.6.2 RESET_N.....	28
3.6.3 SAFEBOOT_N.....	28
3.6.4 TIMEPULSE.....	29
3.6.5 TX_READY.....	29
3.6.6 EXTINT.....	29
3.7 Multiple GNSS assistance (MGA).....	30
3.7.1 Authorization.....	30
3.7.2 Multiple servers.....	30

3.7.3 Preserving information during power-off.....	31
3.7.4 AssistNow Online.....	31
3.7.5 AssistNow Offline.....	35
3.7.6 AssistNow Autonomous.....	38
3.7.7 Save-on-Shutdown feature.....	42
3.8 Power management.....	43
3.8.1 Continuous mode.....	44
3.8.2 Power save mode.....	44
3.8.3 Peak current settings.....	51
3.8.4 Power on/off command.....	52
3.8.5 EXTINT pin control when power save mode is not active.....	52
3.8.6 Measurement and navigation rate with power save mode.....	52
3.8.7 Backup modes.....	52
3.9 Clocks and time.....	53
3.9.1 Receiver local time.....	53
3.9.2 Navigation epochs.....	53
3.9.3 iTOW timestamps.....	54
3.9.4 GNSS times.....	54
3.9.5 Time validity.....	54
3.9.6 UTC representation.....	55
3.9.7 Leap seconds.....	56
3.9.8 Real time clock.....	56
3.9.9 Date.....	56
3.10 Timing functionality.....	57
3.10.1 Time pulse.....	57
3.10.2 Timemark.....	61
3.11 Security.....	62
3.11.1 Spoofing detection / monitoring.....	63
3.11.2 Jamming/interference indicator.....	63
3.11.3 GNSS receiver integrity.....	64
3.12 u-blox protocol feature descriptions.....	64
3.12.1 Broadcast navigation data.....	64
3.13 Forcing a receiver reset.....	68
3.14 Firmware update.....	69
4 Design.....	70
4.1 Pin assignment.....	70
4.2 NEO-M9N minimal design.....	71
4.3 Power supply.....	72
4.3.1 VCC: Main supply voltage.....	72
4.3.2 V_BCKP: Backup supply voltage.....	72
4.3.3 V_USB: USB interface power supply.....	73
4.3.4 NEO-M9N power supply.....	73
4.4 NEO-M9N internal components.....	73
4.4.1 Clock generation.....	73
4.4.2 Real time clock (RTC).....	73
4.4.3 SAW and LNA.....	74
4.4.4 VCC_RF antenna bias voltage.....	74
4.4.5 Flash memory.....	74
4.5 Antenna.....	74
4.5.1 Antenna design with passive antenna.....	74

4.5.2 Antenna design with external LNA or active antenna.....	75
4.6 EOS/ESD precautions.....	77
4.6.1 ESD protection measures.....	77
4.6.2 EOS precautions.....	77
4.6.3 Safety precautions.....	78
4.7 Electromagnetic interference on I/O lines.....	78
4.7.1 General notes on interference issues.....	78
4.7.2 In-band interference mitigation.....	79
4.7.3 Out-of-band interference.....	79
4.8 Layout.....	80
4.8.1 Placement.....	80
4.8.2 Package footprint, copper and paste mask.....	80
4.8.3 Layout guidance.....	82
4.9 Design guidance.....	83
4.9.1 General considerations.....	83
4.9.2 Backup battery.....	84
4.9.3 RF front-end circuit options.....	84
4.9.4 Antenna/RF input.....	85
4.9.5 Ground pads.....	85
4.9.6 Schematic design.....	85
4.9.7 Layout design-in guideline.....	85
5 Product handling.....	86
5.1 ESD handling precautions.....	86
5.2 Soldering.....	86
5.3 Packaging.....	89
5.4 Reels.....	89
5.5 Tapes.....	89
5.6 Moisture sensitivity levels.....	90
Appendix.....	91
A Migration.....	91
B Glossary.....	91
Related documents.....	93
Revision history.....	94

1 Integration manual structure

This manual provides a wealth of information to enable a successful design with the NEO-M9N standard precision GNSS receiver. The manual is structured according to system, software and hardware aspects.

The first section, "System description" gives an overview of the NEO-M9N standard precision GNSS receiver with a block diagram of NEO-M9N.

The following section "Receiver functionality" provides an exhaustive description of the receiver's functionality. Beginning with the new configuration messages, both existing and new users should read this section to understand the new message types employed. Most of the following subsections should be familiar to existing users of u-blox positioning products, however some changes are introduced owing to the new configuration messages.

The sections from "Design" onwards address hardware options when designing NEO-M9N into a new product. This part gives power supply recommendations and provides guidance for circuit design and PCB layout assistance. The antenna and RF front-end sections provide design information and recommendations for these essential components. The final "Design guidance" section helps the designer to check that crucial aspects of the design-in process have been carried out.

The final section addresses the general product handling concerns giving guidance on ESD precautions, production soldering considerations and tape and reel packaging information.

In the appendix, the glossary as well as migration information can be found.

2 System description

2.1 Overview

The NEO-M9N GNSS receiver features the u-blox M9 standard precision GNSS platform, and provides exceptional sensitivity and acquisition times for all L1 GNSS systems. u-blox M9 receivers are available in different variants to serve automotive and industrial tracking applications, such as navigation, telematics and UAVs.

The u-blox M9 standard precision GNSS platform, which delivers meter-level accuracy, succeeds the well-known u-blox M8 product range.

u-blox M9 receivers support concurrent reception of four GNSS. The high number of visible satellites allows the receiver to select the best signals. This maximizes the position accuracy, in particular under challenging conditions such as deep urban canyons.

u-blox M9 receivers detect jamming and spoofing events and report them to the host, which allows the system to react to such events. Advanced filtering algorithms mitigate the impact of RF interference and jamming, thus enabling the product to operate as intended.

The receiver also provides higher navigation rate and improved security features compared to previous u-blox GNSS generations.

The NEO-M9N module is available in the 12.2 x 16.0 mm NEO form factor LCC package.

2.2 Architecture

The NEO-M9N receiver provides all the necessary RF and baseband processing to enable multi-constellation operation. The block diagram below shows the key functionality.

2.2.1 Block diagram

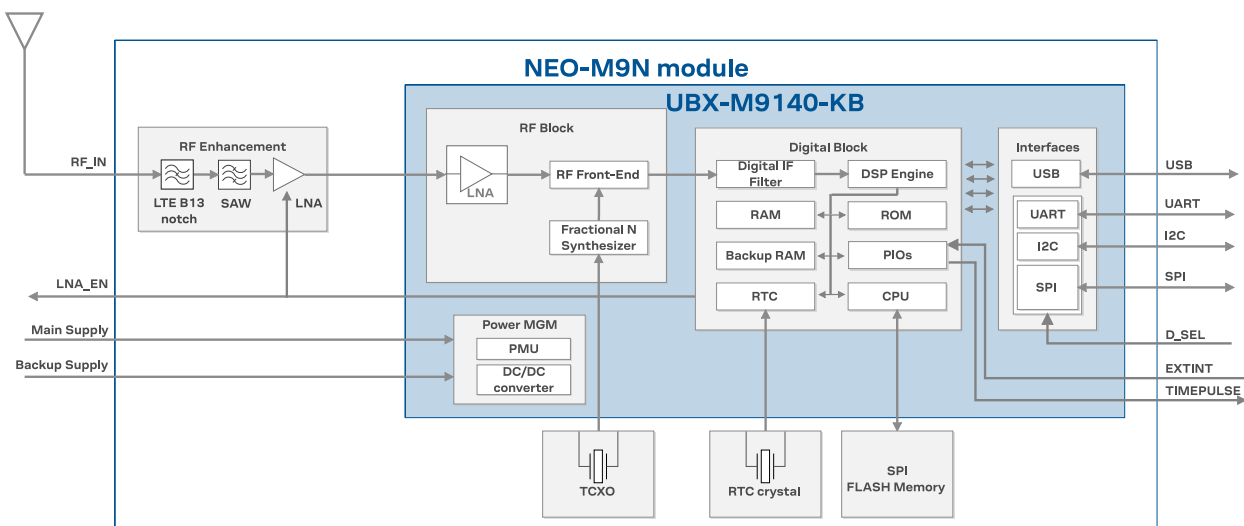

Figure 1: NEO-M9N block diagram

3 Receiver functionality

This section describes the NEO-M9N operational features and their configuration.

3.1 Receiver configuration

The NEO-M9N is fully configurable with UBX configuration interface keys. The configuration database in the receiver's RAM holds the current configuration, which is used by the receiver at run-time. It is constructed on start-up of the receiver from several sources of configuration. The configuration interface and the available keys are described fully in the NEO-M9N Interface description [2].

A configuration setting stored in RAM remains effective until power-down or reset. If stored in BBR (battery backed RAM), the setting will be used as long as the backup battery supply remains. Configuration settings can be saved permanently in flash memory.



The configuration interface has changed from earlier u-blox positioning receivers. There is some backwards compatibility, however, users are strongly advised to adopt the configuration interface described in this document. See legacy UBX-CFG message fields reference section in the NEO-M9N Interface description [2].

Configuration interface settings are held in a database consisting of separate configuration items. An item is made up of a pair consisting of a key ID and a value. Related items are grouped together and identified under a common group name: CFG-GROUP-*; a convention used in u-center and within this document. Within u-center, a configuration group is identified as "Group name" and the configuration item is identified as the "item name" under the "Generation 9 Configuration View" - "Advanced Configuration" view.

The UBX messages available to change or poll the configurations are the UBX-CFG-VALSET, UBX-CFG-VALGET, and UBX-CFG-VALDEL messages. For more information about these messages and the configuration keys see the configuration interface section in the NEO-M9N Interface description [2].

3.1.1 Changing the receiver configuration

All configuration messages, including legacy UBX-CFG messages, will result in a UBX-ACK-ACK or UBX-ACK-NAK response. If several configuration messages are sent without waiting for this response then the receiver may pause processing of input messages until processing of a previous configuration message has been completed. When this happens a warning message "wait for cfg ACK" will be sent to the host.

3.1.2 Legacy configuration interface compatibility

There is some backwards-compatibility for the legacy UBX-CFG configuration messages. It is strongly recommended to adopt the new configuration interface, as the legacy configuration messages support will be removed in the future.

See Legacy UBX-CFG Message Fields Reference section in the NEO-M9N Interface description [2].

3.1.3 Basic receiver configuration

This section summarizes the basic receiver configuration most commonly used.

3.1.3.1 Basic hardware configuration

The NEO-M9N receiver has been configured with default setting already during the module production. The receiver starts up and is fully operational as soon as proper power supply, communication interfaces and antenna signal from the application have been connected.

3.1.3.2 Communication interface configuration

Several configuration groups allow operation mode configuration of the various communications interfaces. These include parameters for the data framing, transfer rate and enabled input/output protocols. See section [Communication interfaces](#) for details. The configuration groups available for each interface are:

Interface	Configuration groups
UART1	CFG-UART1-*, CFG-UART1INPROT-*, CFG-UART1OUTPROT-*
USB	CFG-USB-*, CFG-USBINPROT-*, CFG-USBOUTPROT-*
I2C	CFG-I2C-*, CFG-I2CINPROT-*, CFG-I2COUTPROT-*
SPI	CFG-SPI-*, CFG-SPIINPROT-*, CFG-SPIOUTPROT-*

Table 1: Interface configurations

3.1.3.3 Message output configuration

This product supports two protocols for output messages. One is NMEA and the other one is a u-blox proprietary "UBX" protocol. NMEA is a well-known industry standard, used mainly for providing information about position, time and satellites. UBX messages can be used to configure the receiver and also to periodically provide information about position, time and satellites. With the UBX protocol it is easy to monitor the receiver status and get much deeper information about the receiver status. The rate of NMEA and UBX protocol output messages are configurable and it is possible to enable or disable single NMEA or UBX messages individually.

If the rate configuration value is zero, then the corresponding message will not be output. Values greater than zero indicate how often the message is output.

For periodic output messages the rate relates to the event the message is related to. For example, the UBX-NAV-PVT (navigation, position, velocity and time solution) is related to the navigation epoch. If the rate of this message is set to one (1), it will be output for every navigation epoch. If the rate is set to two (2), it will be output every other navigation epoch. The rates of the output messages are individually configurable per communication interface. See the CFG-MSGOUT-* configuration group.

Some messages, such as UBX-MON-VER, are not periodic and will only be output as an answer to a poll request.

The UBX-INF-* and NMEA-Standard-TXT information messages are non-periodic output messages that do not have a message rate configuration. Instead they can be enabled for each communication interface via the CFG-INFMSG-* configuration group.



All message output is additionally subject to the protocol configuration of the communication interfaces. Messages of a given protocol will not be output until the protocol is enabled for output on the interface (see the previous section).

3.1.3.4 GNSS signal configuration

The GNSS constellations are configurable with configuration keys. Each GNSS constellation can be enabled or disabled independently.

3.1.4 Default GNSS configuration

The NEO-M9N default GNSS configuration is set as follows:

- GPS: L1C/A
- GLONASS: L1OF
- Galileo: E1B/C
- BeiDou: B1I
- QZSS: L1C/A
- SBAS: L1C/A

For more information about default configuration, see the NEO-M9N Interface description [2].

3.1.5 Default interface settings

Interface	Settings
UART	38400 baud, 8 bits, no parity bit, 1 stop bit. Output messages: NMEA GGA, GLL, GSA, GSV, RMC, VTG, TXT (no UBX). Input protocols: UBX, NMEA and RTCM 3.3.
USB	Output messages activated as in UART. Input protocols available as in UART.
I2C	Output messages activated as in UART. Input protocols available as in UART.
SPI	Output messages activated as in UART. Input protocols available as in UART.

Table 2: Default interface settings



Refer to the u-blox NEO-M9N Interface description [2] for information about further settings.

By default the NEO-M9N outputs NMEA 4.10 messages that include satellite data for all GNSS bands being received. This results in a higher-than-before NMEA load output for each navigation period. Make sure the UART baud rate being used is sufficient for the selected navigation rate and the number of GNSS signals being received.

3.1.6 Navigation configuration

This section presents various configuration options related to the navigation engine. These options can be configured through CFG-NAVSPG-* configuration keys.

3.1.6.1 Platform settings

u-blox receivers support different dynamic platform models (see in the table below) to adjust the navigation engine to the expected application environment. These platform settings can be changed dynamically without performing a power cycle or reset. The settings improve the receiver's interpretation of the measurements and thus provide a more accurate position output. Setting the receiver to an unsuitable platform model for the given application environment is likely to result in a loss of receiver performance and position accuracy.

The dynamic platform model can be configured through the CFG-NAVSPG-DYNMODEL configuration item. The supported dynamic platform models and their details can be seen in [Table 3](#) and [Table 4](#) below.

Platform	Description
Portable (default)	Applications with low acceleration, e.g. portable devices. Suitable for most situations.
Stationary	Used in timing applications (antenna must be stationary) or other stationary applications. Velocity restricted to 0 m/s. Zero dynamics assumed.
Pedestrian	Applications with low acceleration and speed, e.g. how a pedestrian would move. Low acceleration assumed.
Automotive	Used for applications with equivalent dynamics to those of a passenger car. Low vertical acceleration assumed.
At sea	Recommended for applications at sea, with zero vertical velocity. Zero vertical velocity assumed. Sea level assumed.
Airborne <1g	Used for applications with a higher dynamic range and greater vertical acceleration than a passenger car. No 2D position fixes supported.
Airborne <2g	Recommended for typical airborne environments. No 2D position fixes supported.
Airborne <4g	Only recommended for extremely dynamic environments. No 2D position fixes supported.
Wrist	Only recommended for wrist-worn applications. Receiver will filter out arm motion.

Table 3: Dynamic platform models

Platform	Max altitude [m]	Max horizontal velocity [m/s]	Max vertical velocity [m/s]	Sanity check type	Max position deviation
Portable	12000	310	50	Altitude and velocity	Medium
Stationary	9000	10	6	Altitude and velocity	Small
Pedestrian	9000	30	20	Altitude and velocity	Small
Automotive	6000	100	15	Altitude and velocity	Medium
At sea	500	25	5	Altitude and velocity	Medium
Airborne <1g	80000	100	100	Altitude	Large
Airborne <2g	80000	250	100	Altitude	Large
Airborne <4g	80000	500	100	Altitude	Large
Wrist	9000	30	20	Altitude and velocity	Medium

Table 4: Dynamic platform model details

Dynamic platforms designed for high acceleration systems (e.g. airborne <2g) can result in a higher standard deviation in the reported position.

If a sanity check against a limit of the dynamic platform model fails, then the position solution is invalidated. [Table 4](#) above shows the types of sanity checks which are applied for a particular dynamic platform model.

3.1.6.2 Navigation input filters

The navigation input filters in CFG-NAVSPG-* configuration group provide the input data of the navigation engine.

Configuration item	Description
CFG-NAVSPG-FIXMODE	By default, the receiver calculates a 3D position fix if possible but reverts to 2D position if necessary (auto 2D/3D). The receiver can be forced to only calculate 2D (2D only) or 3D (3D only) positions.
CFG-NAVSPG-CONSTR_ALT, CFG-NAVSPG-CONSTR_ALTVAR	The fixed altitude is used if fixMode is set to 2D only. A variance greater than zero must also be supplied.
CFG-NAVSPG-INFIL_MINELEV	Minimum elevation of a satellite above the horizon in order to be used in the navigation solution. Low elevation satellites may provide degraded accuracy, due to the long signal path through the atmosphere.

Configuration item	Description
CFG-NAVSPG-INFIL_NCNOTHRIS, CFG-NAVSPG-INFIL_CNOTHRIS	A navigation solution will only be attempted if there are at least the given number of SVs with signals at least as strong as the given threshold.

Table 5: Navigation input filter parameters

If the receiver only has three SVs for calculating a position, the navigation algorithm uses a constant altitude to compensate for the missing fourth SV. When a SV is lost after a successful 3D fix (min. four SVs available), the altitude is kept constant at the last known value. This is called a 2D fix.

 u-blox receivers do not calculate any navigation solution with less than three SVs.

3.1.6.3 Navigation output filters

The result of a navigation solution is initially classified by the fix type (as detailed in the `fixType` field of UBX-NAV-PVT message). This distinguishes between failures to obtain a fix at all ("No Fix") and cases where a fix has been achieved, which are further subdivided into specific types of fixes (e.g. 2D, 3D, dead reckoning).

 The NEO-M9N firmware does not support the dead reckoning position fix type.

Where a fix has been achieved, a check is made to determine whether the fix should be classified as valid or not. A fix is only valid if it passes the navigation output filters as defined in CFG-NAVSPG-OUTFIL. In particular, both PDOP and accuracy values must be below the respective limits.

 Important: Users are recommended to check the `gnssFixOK` flag in the UBX-NAV-PVT or the NMEA valid flag. Fixes not marked valid should not be used.

UBX-NAV-STATUS message also reports whether a fix is valid in the `gpsFixOK` flag. These messages have only been retained for backwards compatibility and users are recommended to use the UBX-NAV-PVT message.

3.1.6.3.1 Speed (3D) low-pass filter

The CFG-ODO-OUTLPELV configuration item offers the possibility to activate a speed (3D) low-pass filter. The output of the speed low-pass filter is published in the UBX-NAV-VELNED message (`speed` field). The filtering level can be set via the CFG-ODO-VELLPGAIN configuration item and must be comprised between 0 (heavy low-pass filtering) and 255 (weak low-pass filtering).

 The internal filter gain is computed as a function of speed. Therefore, the level as defined in the CFG-ODO-VELLPGAIN configuration item defines the nominal filtering level for speeds below 5 m/s.

3.1.6.3.2 Low-speed course over ground filter

The CFG-ODO-USE_COG activates this feature and the CFG-ODO-COGMAXSPEED, CFG-ODO-COGMAXPOSACC configuration items offer the possibility to configure a low-speed course over ground filter (also named heading of motion 2D). This filter derives the course over ground from position at very low speed. The output of the low-speed course over ground filter is published in the UBX-NAV-PVT message (`headMot` field), UBX-NAV-VELNED message (`heading` field), NMEA-RMC message (`cog` field) and NMEA-VTG message (`cogt` field). If the low-speed course over ground filter is not configured, then the course over ground is computed as described in section [Freezing the course over ground](#).

3.1.6.4 Static hold

Static hold mode allows the navigation algorithms to decrease the noise in the position output when the velocity is below a pre-defined "Static Hold Threshold". This reduces the position wander caused by environmental factors such as multi-path and improves position accuracy especially in stationary applications. By default, static hold mode is disabled.

If the speed drops below the defined "Static Hold Threshold", the static hold mode will be activated. Once static hold mode has been entered, the position output is kept static and the velocity is set to zero until there is evidence of movement again. Such evidence can be velocity, acceleration, changes of the valid flag (e.g. position accuracy estimate exceeding the position accuracy mask, see also section [Navigation output filters](#)), position displacement, etc.

The CFG-MOT-GNSSDIST_THRS configuration item additionally allows for configuration of distance threshold. If the estimated position is farther away from the static hold position than this threshold, static mode will be quit. The CFG-MOT-GNSSSPEED_THRS configuration item allows you to set a speed that the static hold will release.

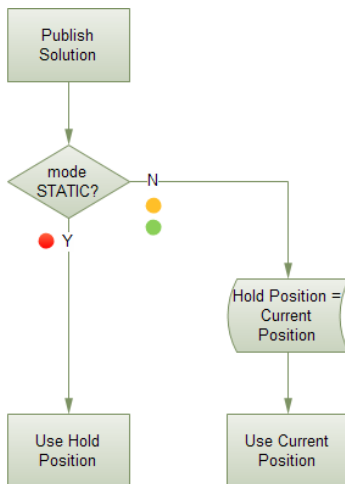

Figure 2: Position publication in static hold mode

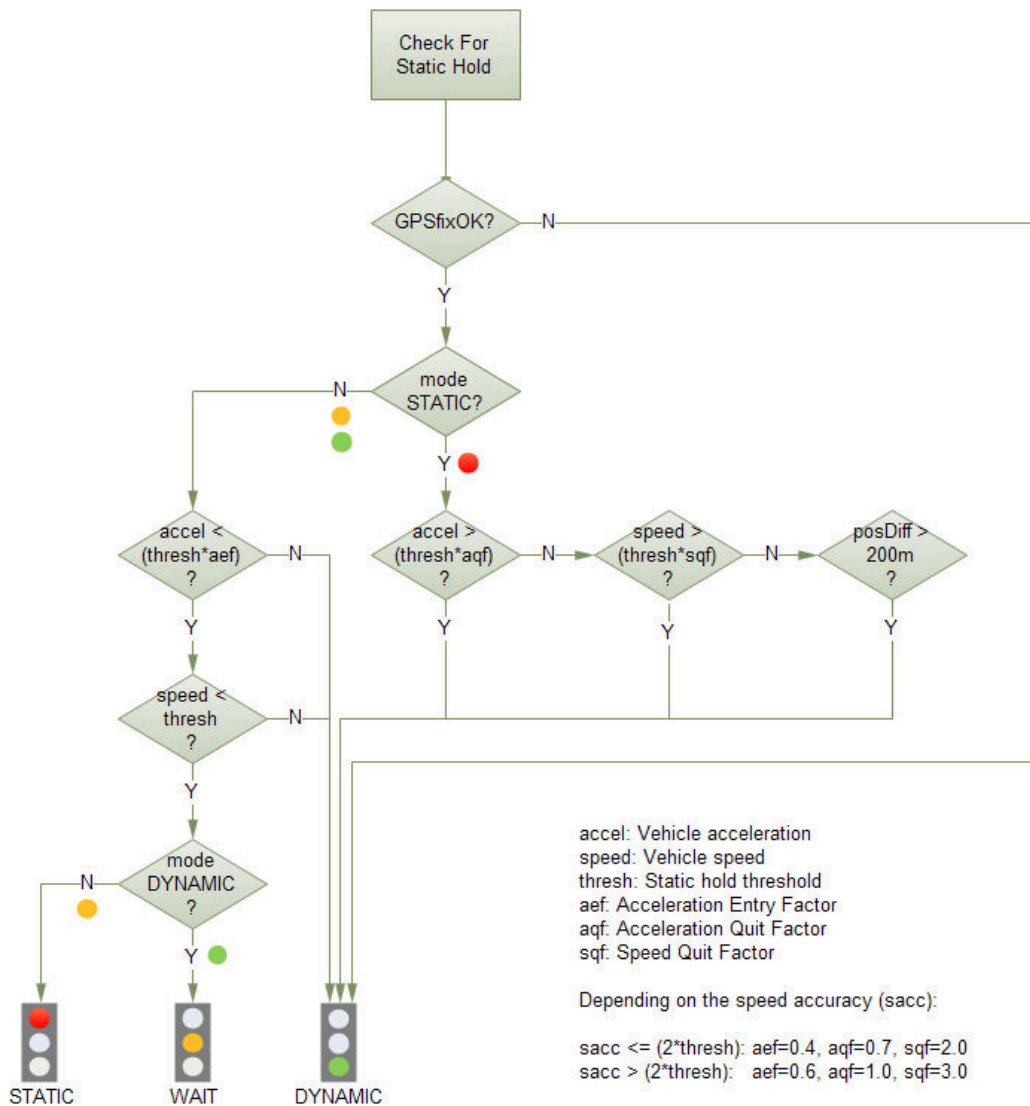

Figure 3: Flowchart of the static hold mode

3.1.6.5 Freezing the course over ground

If the low-speed course over ground filter is deactivated or inactive (see section [Low-speed course over ground filter](#)), the receiver derives the course over ground from the GNSS velocity information. If the velocity cannot be calculated with sufficient accuracy (e.g., with bad signals) or if the absolute speed value is very low (under 0.1 m/s) then the course over ground value becomes inaccurate too. In this case the course over ground value is frozen, i.e. the previous value is kept and its accuracy is degraded over time. These frozen values will not be output in the NMEA messages NMEA-RMC and NMEA-VTG unless the NMEA protocol is explicitly configured to do so (see NMEA protocol configuration in the NEO-M9N Interface description [2]).

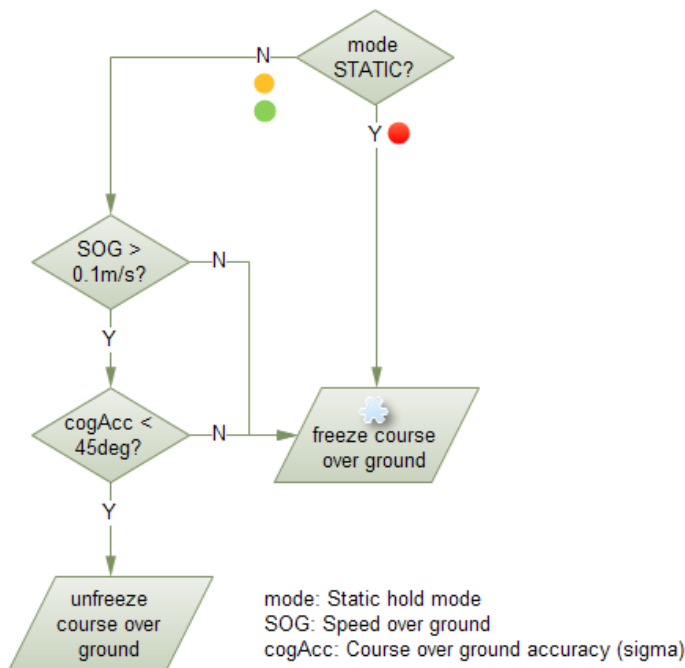

Figure 4: Flowchart of the course over ground freezing

3.1.6.6 Signal attenuation compensation

In normal operating conditions, low signal strength indicates likely contamination by multipath. The receiver trusts such signals less in order to preserve the quality of the position solution in poor signal environments. This feature can result in degraded performance in situations where the signals are attenuated for another reason, for example due to antenna placement. In this case, the signal attenuation compensation feature can be used to restore normal performance. There are three possible modes:

- Disabled: no signal attenuation compensation is performed
- Automatic: the receiver automatically estimates and compensates for the signal attenuation
- Configured: the receiver compensates for the signal attenuation based on a configured value

These modes can be selected using CFG-NAVSPG-SIGATTCOMP. In the case of the "configured" mode, the user should input the maximum C/N0 observed in a clear-sky environment, excluding any outliers or unusually high values. The configured value can have a large impact on the receiver performance, so should be chosen carefully.

3.2 Geofencing

3.2.1 Introduction

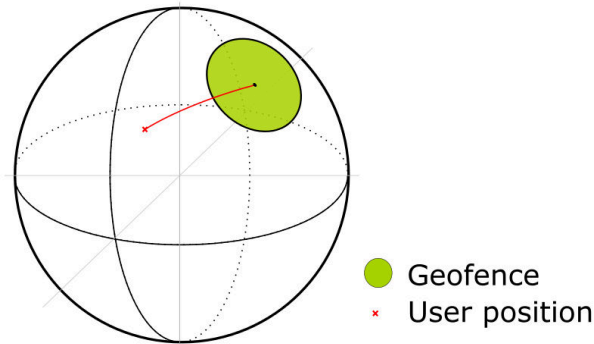

Figure 5: Geofence

The geofencing feature allows for the configuration of up to four circular areas (geofences) on the Earth's surface. The receiver will then evaluate for each of these areas whether the current position lies within the area or not and signal the state via UBX messaging and PIO toggling.

3.2.2 Interface

Geofencing can be configured using the CFG-GEOFENCE-* configuration group. The geofence evaluation is active whenever there is at least one geofence configured.

The current state of each geofence plus the combined state is output in UBX-NAV-GEOFENCE with every navigation epoch.

Additionally the user can configure the receiver to output the combined geofence state on a physical pin (assigned to a PIO being used for geofence state indication).

3.2.3 Geofence state evaluation

With every navigation epoch the receiver will evaluate the current solution's position versus the configured geofences. There are three possible outcomes for each geofence:

- *Inside* - The position is inside the geofence with the configured confidence level
- *Outside* - The position lies outside of the geofence with the configured confidence level
- *Unknown* - There is no valid position solution or the position uncertainty does not allow for unambiguous state evaluation

The position solution uncertainty (standard deviation) is multiplied with the configured confidence sigma level number and taken into account when evaluating the geofence state (red circle in figure below).

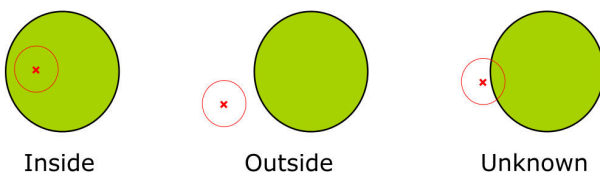

Figure 6: Geofence states

The combined state for all geofences is evaluated as the combination (logical OR) of all geofences:

- *Inside* - The position lies inside of at least one geofence
- *Outside* - The position lies outside of all geofences
- *Unknown* - All remaining states

3.2.4 Using a PIO for geofence state output

This feature can be used for example for waking up a sleeping host when a defined geofence condition is reached. The receiver will toggle the assigned pin according to the *combined* geofence state. Due to hardware restrictions, the unknown state will always be represented as HIGH. If the receiver is in software backup or in a reset, the pin will go to HIGH accordingly. The meaning of the LOW state can be configured using the CFG-GEOFENCE-PINPOL configuration item.



The CFG-GEOFENCE-PIN configuration item refers to a PIO and not a physical device pin. The PIO number must be set that is mapped to the assigned geofence state device pin.

3.3 Logging

3.3.1 Introduction

The logging feature allows position fixes and arbitrary byte strings from the host to be logged in flash memory attached to the receiver. Logging of position fixes happens independently of the host system, and can continue while the host is powered down.

The following table lists all the logging-related messages:

Message	Description
UBX-LOG-CREATE	Creates a log file and activates the logging system
UBX-LOG-ERASE	Erases a log file and deactivates the logging subsystem
UBX-LOG-INFO	Provides information about the logging system
UBX-LOG-STRING	Enables a host process to write a string of bytes to the log file

Table 6: Logging control and configuration messages

Message	Description
UBX-LOG-RETRIEVE	Starts the log retrieval process
UBX-LOG-RETRIEVEPOS	A position log entry returned by the receiver
UBX-LOG-RETRIEVEPOSEXTRA	Odometer position data
UBX-LOG-RETRIEVESTRING	A byte string log entry returned by the receiver
UBX-LOG-FINDTIME	Finds the index of the first entry (given time)

Table 7: Logging retrieval messages

3.3.2 Setting the logging system up

An empty log can be created using the UBX-LOG-CREATE message and a log can be deleted with the UBX-LOG-ERASE message. The logging system will only be running if a log is in existence, so most logging messages will be rejected with an UBX-ACK-NAK message if there is no log present. Only one log can be created at any one time so an UBX-ACK-NAK message will be returned if a log already exists. The message specifies the maximum size of the log in bytes (with some pre-set values provided). Both the logging subsystem and the receiver file-store have implementation overheads, so total space available for log entries will be somewhat smaller than the size specified.

UBX-LOG-CREATE also allows the log to be specified as a circular log. If the log is circular, a set of older log entries will be deleted when it fills up, and the space freed up is used for new log entries. By contrast, if a non-circular log becomes full then new entries which do not fit will be rejected. UBX-LOG-CREATE also causes the logging system to start up so that further logging messages can be

processed. The logging system will start up automatically on power-up if there is a log in existence. The log will remain in the receiver until specifically erased using the UBX-LOG-ERASE message.

The CFG-LOGFILTER-* configuration group controls whether logging of entries is currently enabled and selects position fix messages for logging.

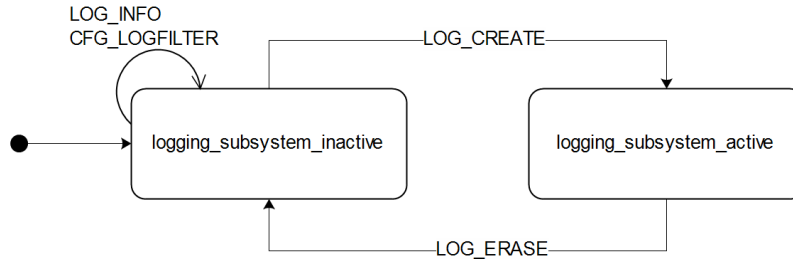

Figure 7: The top level active/inactive states of the logging subsystem

3.3.3 Information about the log

The receiver can be polled for a UBX-LOG-INFO message which will give information about the log. This will include the maximum size that the log can grow to (which, due to overheads, will be smaller than that requested in UBX-LOG-CREATE) and the amount of log space currently occupied. It will also report the number of entries currently in the log together with the time and date of the newest and oldest messages which have a valid time stamp.

Log entries are compressed and have housekeeping information associated with them, so the actual space occupied by log messages may be difficult to predict. The minimum size for a position fix entry is 9 bytes and the maximum 24 bytes, the typical size is 10 or 11 bytes. If the odometer is enabled then this will use at least another three bytes per fix.

Each log also has a fixed overhead which is dependent on the log type. The approximate size of this overhead is shown in the following table.

Log type	Overhead
circular	Up to 40 kB
non-circular	Up to 8 kB

Table 8: Log overhead size

The number of entries that can be logged in any given flash size can be estimated as follows:

Approx. number of entries = (flash size available for logging - log overhead)/typical entry size

For example, if 1500 kB of flash is available for logging (after other flash usage such as the firmware image is taken into account) a non-circular log would be able to contain approximately 139000 entries: $((1500 \times 1024) - (8 \times 1024)) / 11 = 138891$.

3.3.4 Recording

The CFG-LOGFILTER-RECORD_ENA configuration must be *true* to enable recording into the log. Nothing will be recorded if recording is disabled, otherwise position fix and UBX-LOG_STRING entries can be recorded. When recording is enabled an entry will also be created from each UBX-LOG-STRING message. These will be timestamped if the receiver has current knowledge of time.

The CFG-LOGFILTER-* configuration group has several values which can be used to select position fix entries for logging. If CFG-LOGFILTER-APPLY_ALL_FILTERS is *false*, then all position fixes will be logged (subject to a maximum rate of 1 Hz). Otherwise, a position is logged if any of the or if

all of MIN_INTERVAL, TIME_THRS, SPEED_THRS or POSITION_THRS thresholds are exceeded. If a threshold is set to zero it is ignored.

Position fixes are only recorded if a valid fix is obtained - failed and invalid fixes are not recorded. Position fixes are compressed to reduce the amount of flash space used. In order to improve the compression, the fix values are rounded. This means that the values returned by the logging system may differ slightly from those that are gathered in real time.

In on/off power save mode it is possible to configure the logging system so that only one fix is recorded for each on period. This will be recorded immediately before the receiver powers off and will be the best fix seen during the on period (in this case, "best" is defined as being the fix with the lowest horizontal accuracy figure). Set CFG-LOGFILTER-ONCE_PER_WAKE_UP_ENA to *true* to activate this logic.

The recorded data for a fix comprises:

- The time and date of the fix recorded to a precision of one second.
- Latitude and longitude to a precision of one millionth of a degree. Depending on position on Earth this is a precision in the order of 0.1 m.
- Altitude (height above mean sea level) to a precision of 0.1 m. Entries with an altitude lower than -470 m (lower than the lowest point on earth) or higher than 20,000 m may not be recorded in the log.
- Ground speed to a precision of 1 cm/s.
- The fix type (only successful fix types, since these are the only ones recorded).
- The number of satellites used in the fix is recorded, but there is a maximum count which can be recorded. If the actual count exceeds this maximum count then the maximum count will be recorded. If a log entry is retrieved with a satellite count equal to the maximum this means that value or more. The maximum count is 51.
- A horizontal accuracy estimate is recorded to give an indication of fix quality. This is an approximate compressed representation of the accuracy as determined by the fix process. Any accuracy less than 0.7 m will be recorded as 0.7 m and any value above 1 km will be recorded as 1 km. Within these limits, the recorded accuracy will always be greater than the fix accuracy number (by up to 40%).
- Heading to a precision of one degree.
- Odometer distance data (if odometer is enabled).

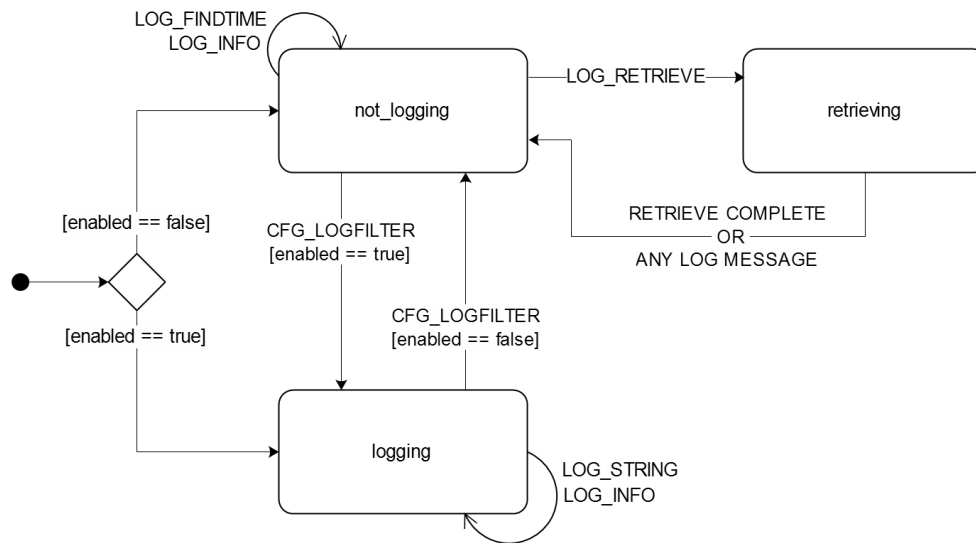

Figure 8: The states of the active logging subsystem

3.3.5 Retrieval

UBX-LOG-RETRIEVE starts the process which allows the receiver to output log entries. UBX-LOG-INFO may be helpful to a host system in order to understand the current log status before retrieval is started.

Once retrieval has started, one message will be output from the receiver for each log entry requested. Sending any logging message to the receiver during retrieval will cause the retrieval to stop before the message is processed.

To maximize the speed of transfer it is recommended that a high communications data rate is used and GNSS processing is stopped during the transfer (see UBX-CFG-RST).

UBX-LOG-RETRIEVE can specify a start-entry index and entry-count. The maximum number of entries that can be returned in response to a single UBX-LOG-RETRIEVE message is 256. If more entries than this are required the message will need to be sent multiple times with different startEntry indices. It may be useful to stop recording via CFG_LOGFILTER-RECORD_ENA while retrieving log entries from a circular log to avoid deletion of the requested entries between the request and transmission.

The receiver will send a UBX-LOG-RETRIEVEPOS message for each position fix log entry and a UBX-LOGRETRIEVESTRING message for each string log entry. If the odometer was enabled at the time a position was logged, then a UBX-LOG-RETRIEVEPOSEXTRA will also be sent. Messages will be sent in the order in which they were logged, so UBX-LOG-RETRIEVEPOS and UBX-LOG-RETRIEVESTRING messages may be interspersed in the message stream.

The UBX-LOG-FINDTIME message can be used to search a log for the index of the first entry less than or equal to the given time. This index can then be used with the UBX-LOG-RETRIEVE message to provide timebased retrieval of log entries.

3.3.6 Command message acknowledgment

Some log operations may take a long time to execute because of the time taken to write to flash memory. The time for some operations may be unpredictable since the number and timing of flash operations may vary. In order to allow host software to synchronize to these delays logging

messages will always produce a response. This will be UBX-ACK-NAK in case of error, otherwise UBX-ACK-ACK unless there is some other defined response to the message.

It is possible to send a small number of logging commands without waiting for acknowledgment, since there is a command queue, but this risks confusion between the acknowledgments for the commands. Also a command queue overflow would result in commands being lost.

3.4 Data batching

3.4.1 Introduction

The data batching feature allows position fixes to be stored in the RAM of the receiver to be retrieved later in one batch. Batching of position fixes happens independently of the host system, and can continue while the host is powered down.

The following tables list all the batching-related messages:

Message	Description
UBX-MON-BATCH	Provides information about the buffer fill level and dropped data due to overrun
UBX-LOG-RETRIEVEBATCH	Starts the batch retrieval process
UBX-LOG-BATCH	A batch entry returned by the receiver

Table 9: Batching-related messages

3.4.2 Setting up the data batching

Data batching is disabled per default and it has to be configured before use via the CFG-BATCH-* configuration group.

The feature must be enabled and the buffer size must be set to greater than 0. It is possible to set up a PIO as a flag that indicates when the buffer is close to filling up. The fill level when this PIO is asserted can be set by the user separately from the buffer size. The notification fill level must not be larger than the buffer size.

If the host does not retrieve the batched fixes before the buffer fills up the oldest fix will be dropped and replaced with the newest.

The RAM available in the chip limits the size of the buffer. To make the best use of the available space users can select what data they want to batch. When batching is enabled a basic set of data is stored and the configuration flags EXTRAPVT and EXTRAODO can be used to store more detailed information about the position fixes. Doing so reduces the number of fixes that can be batched.

The receiver will reject configuration if it cannot allocate the required buffer memory. To ensure robust operation of the receiver the following limits are enforced:

EXTRAPVT	EXTRAODO	Maximum number of epochs
0	0	300
0	1	221
1	0	156
1	1	132

Table 10: Maximum number of batched epochs



It is recommended to disable all periodic output messages when using batching. This improves system robustness and also helps ensure that the output of batched data is not delayed by other messages.

-  The buffer size is set up in terms of navigation epochs. This means that the time that can be covered with a certain buffer depends on the navigation rate. This rate can be set via the "CFG-RATE-" configuration group.

3.4.3 Retrieval



UBX-LOG-RETRIEVEBATCH starts the process which allows the receiver to output batch entries. Batching must not be stopped for readout; all batched data is lost when the feature is disabled.

Batched fixes are always retrieved starting with the oldest fix in the buffer and progressing towards newer ones. There is no way to skip certain fixes during retrieval.

When a UBX-LOG-RETRIEVEBATCH message is sent the receiver transmits all batched fixes. It is recommended to send a retrieval request with `sendMonFirst` set. This way the receiver will send a UBX-MON-BATCH message first that contains the number of fixes in the batching buffer. This information can be used to detect when the u-blox receiver finishes sending data.

Once retrieval has started, the receiver will first send UBX-MON-BATCH if `sendMonFirst` option was selected in the UBX-LOG-RETRIEVEBATCH. After that, it will send UBX-LOG-BATCH messages with the batched fixes.

To maximize the speed of transfer it is recommended that a high communications data rate is used.

-  The receiver will discard retrieval request while processing a previous UBX-LOG-RETRIEVEBATCH message.
-  The receiver does **not** acknowledge the reception of UBX-LOG-RETRIEVEBATCH; the response that the host should expect are the reply messages.

3.5 Communication interfaces

NEO-M9N provides UART1, SPI, I2C and USB interfaces for communication with a host CPU. The interfaces are configured via the configuration interface which is described in the NEO-M9N interface description [2]. Each protocol can be enabled on several ports at the same time (multi-port capability) with individual settings (e.g. baud rate, message rates, etc.) for each port. Furthermore, more than one protocol can be enabled on a single port at the same time (multi-protocol capability).

-  Be aware that if hardware backup mode is used a proper isolation of the interfaces is needed. How to implement the isolation is described in the [Hardware backup](#) topic.

3.5.1 UART interface

UART1 can be used as a host interface. It supports a configurable baud rate and protocol selection.

The serial ports consist of an RX and a TX line. Neither handshaking signals nor hardware flow control signals are available. These serial ports operate in asynchronous mode. The baud rates can be configured individually for each serial port. However, there is no support for setting different baud rates for reception and transmission.

-  The UART RX interface will be disabled when more than 100 frame errors are detected during a one-second period. This can happen if the wrong baud rate is used or the UART RX pin is grounded. An error message appears when the UART RX interface is re-enabled at the end of the one-second period.

Baud rate	Data bits	Parity	Stop bits
9600	8	none	1
19200	8	none	1
38400	8	none	1

Baud rate	Data bits	Parity	Stop bits
57600	8	none	1
115200	8	none	1
230400	8	none	1
460800	8	none	1
921600	8	none	1

Table 11: Possible UART interface configurations

 The default baud rate is 38400 baud. To prevent buffering problems it is recommended not to run at a lower baud rate than the default.

Note that for protocols such as NMEA or UBX, it does not make sense to change the default word length values (data bits) since these properties are defined by the protocol and not by the electrical interface.

If the amount of data configured is too much for a certain port's bandwidth (e.g. all UBX messages output on a UART port with a baud rate of 9600), the buffer will fill up. Once the buffer space is exceeded, new messages to be sent will be dropped. To prevent message loss, the baud rate and communication speed or the number of enabled messages should be carefully selected so that the expected number of bytes can be transmitted in less than one second.

3.5.2 I2C interface

An I2C interface is available for communication with an external host CPU or u-blox cellular modules. The interface can be operated in slave mode only. The I2C protocol and electrical interface are fully compatible with the fast-mode of the I2C industry standard. Since the maximum SCL clock frequency is 400 kHz, the maximum transfer rate is 400 kb/s. The SCL and SDA pins have internal pull-up resistors which should be sufficient for most applications. However, depending on the speed of the host and the load on the I2C lines additional external pull-up resistors may be necessary.

 To use the I2C interface D_SEL pin must be left open.

3.5.2.1 I2C register layout

The I2C interface allows 256 registers to be addressed. As shown in [Figure 9](#), only three of these are currently implemented.

The data registers 0 to 252 at addresses 0x00 to 0xFC contain information that will be defined later - the result from their reading is currently undefined. The data registers 0 to 252 are 1 byte size.

At addresses 0xFd and 0xFE it is possible to read the currently available number of bytes.

The register at address 0xFF allows the data stream to be read. If there is no data awaiting transmission from the receiver, then this register delivers value 0xFF, which cannot be the first byte of a valid message. If the message data is ready for transmission, the successive reads of register 0xFF will deliver the waiting message data.

 Do not use registers 0x00 to 0xFC. They are reserved for future use and they do not currently provide any meaningful data.

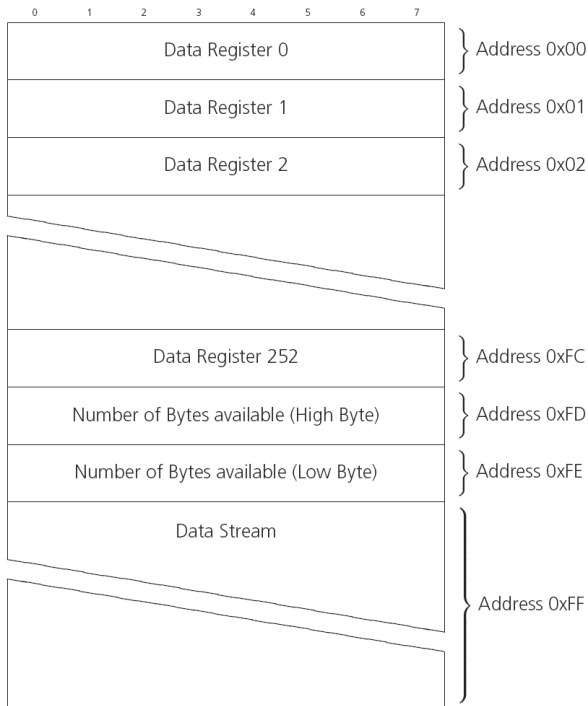

Figure 9: I2C register layout

3.5.2.2 Read access forms

There are two forms of I2C read transfer. The first one, the "random access" form includes a slave register address and thus allows any register to be read. The second one, the "current address" form omits the register address.

Figure 10 shows the format of the first one, the "random access" form of the request. Following the start condition from the master, the 7-bit device address and the RW bit (which is a logic low for write access) are clocked onto the bus by the master transmitter. The receiver answers with an acknowledge (logic low) to indicate that it recognizes the address.

Next, the 8-bit address of the register to be read must be written to the bus. Following the receiver's acknowledgment, the master again triggers a start condition and writes the device address, but this time the RW bit is a logic high to initiate the read access. Now, the master can read 1 to N bytes from the receiver, generating a not-acknowledge and a stop condition after the last byte being read.

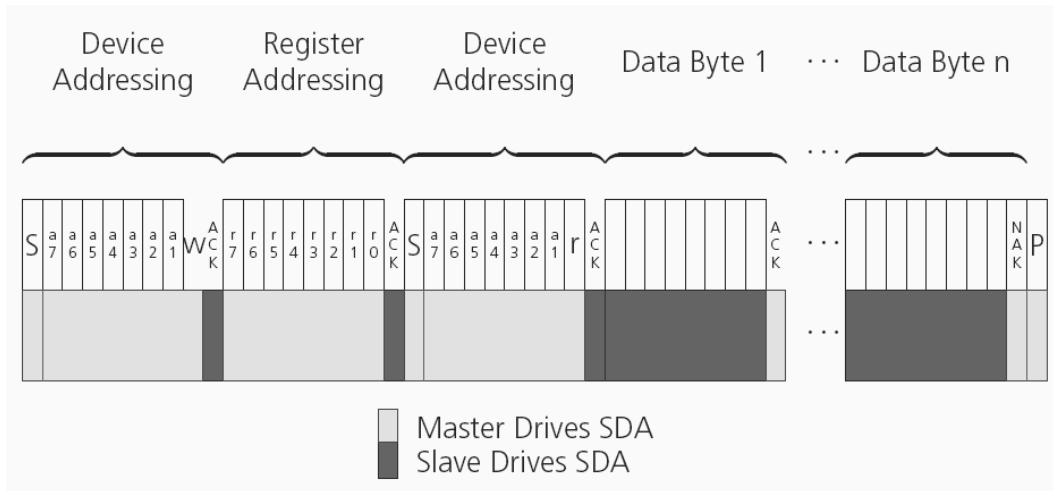

Figure 10: I2C random read access

If the second form, "current address" is used, an address pointer in the receiver is used to determine which register to read. This address pointer will increment after each read unless it is already pointing at register 0xFF, the highest addressable register, in which case it remains unaltered.

The initial value of this address pointer at start-up is 0xFF, so by default all current address reads will repeatedly read register 0xFF and receive the next byte of message data (or 0xFF if no message data is waiting).

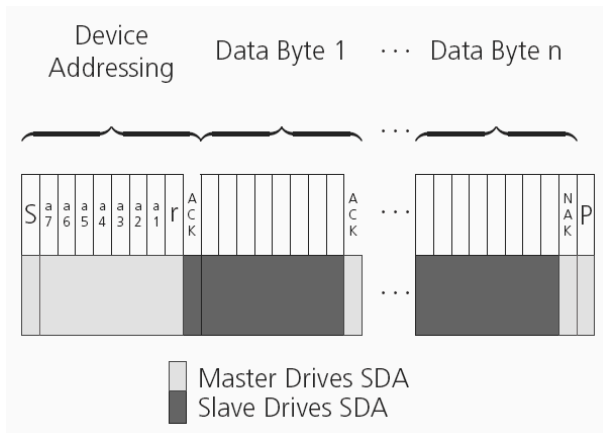

Figure 11: I2C current address read access

3.5.2.3 Write access

The receiver does not provide any write access except for writing UBX and NMEA messages to the receiver, such as configuration or aiding data. Therefore, the register set mentioned in section [Read access](#) is not writeable.

Following the start condition from the master, the 7-bit device address and the RW bit (which is a logic low for write access) are clocked onto the bus by the master transmitter. The receiver answers with an acknowledge (logic low) to indicate that it is responsible for the given address.

The master can write 2 to N bytes to the receiver, generating a stop condition after the last byte being written. The number of data bytes must be at least 2 to properly distinguish from the write access to set the address counter in random read accesses.

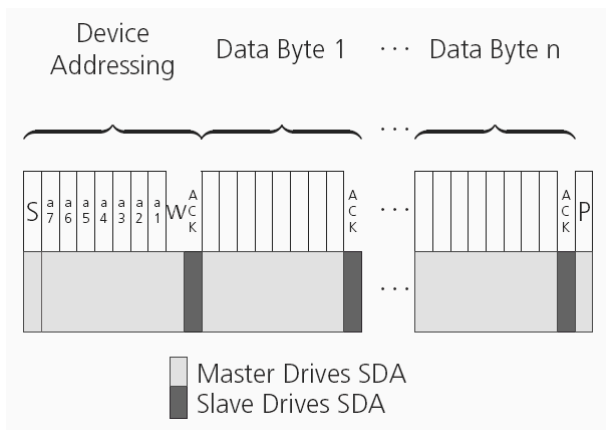

Figure 12: I2C write access

3.5.3 SPI interface

The NEO-M9N standard precision GNSS receiver has an SPI slave interface that can be selected by setting `D_SEL = 0`. The SPI slave interface is shared with UART1 and I2C port. The SPI pins available are: `SPI_MISO` (TXD), `SPI_MOSI` (RXD), `SPI_CS_N` and `SPI_CLK`.

The SPI interface is designed to allow communication to a host CPU. The interface can be operated in slave mode only.

The maximum transfer rate using SPI is 150 kBytes/s and the maximum SPI clock frequency is 5.5 MHz.

3.5.3.1 Read access

As the register mode is not implemented for the SPI port, only the UBX/NMEA message stream is provided. This stream is accessed using the back-to-back read and write access (see section [Back-to-back read and write access](#) below). When no data is available to be written to the receiver, `MOSI` should be held logic high, i.e. all bytes written to the receiver are set to `0xFF`.

To prevent the receiver from being busy parsing incoming data, the parsing process is stopped after 50 subsequent bytes containing `0xFF`. The parsing process is re-enabled with the first byte not equal to `0xFF`.

If the receiver has no more data to send, it sets `MISO` to logic high, i.e. all bytes transmitted decode to `0xFF`. An efficient parser in the host will ignore all `0xFF` bytes which are not part of a message and will resume data processing as soon as the first byte not equal to `0xFF` is received.

3.5.3.2 Back-to-back read and write access

The receiver does not provide any write access except for writing UBX and NMEA messages to the receiver, such as configuration or aiding data. For every byte written to the receiver, a byte will simultaneously be read from the receiver. While the master writes to `MOSI`, at the same time it needs to read from `MISO`, as any pending data will be output by the receiver with this access. The data on `MISO` represents the results from a current address read, returning `0xFF` when no more data is available.

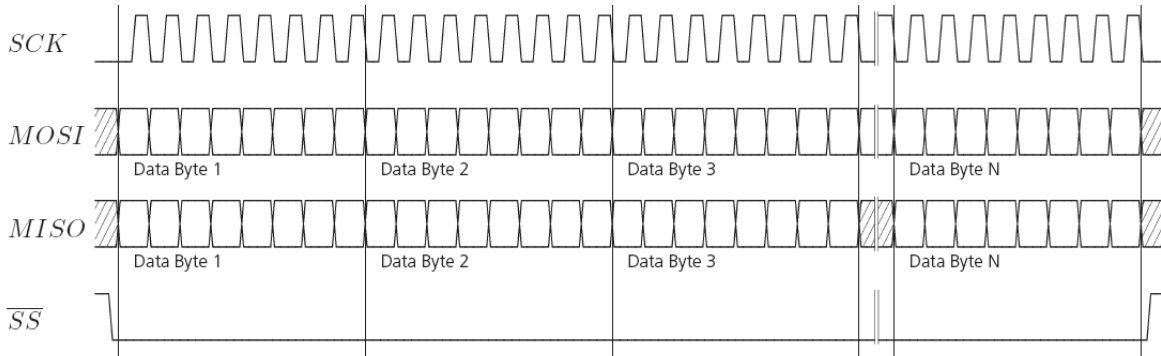







Figure 13: SPI back-to-back read/write access

3.5.4 USB interface

A single USB port is provided for host communication purposes.

The USB interface is compatible with a USB version 2.0 FS (full speed, 12 Mb/s) interface.

The NEO-M9N receiver supports only self-powered mode operation in which the receiver is supplied from its own power supply. The V_USB pin is used to detect the availability of the USB port, i.e. whether the receiver is connected to a USB host. The receiver draws only minimal amount of current (~ 1 mA) from V_USB.

-  USB bus-powered mode is not supported.
-  USB suspend mode is not supported.
-  It is important to connect V_USB to ground when the USB interface is not used in an application.
-  The voltage range for V_USB is specified from 3.0 V to 3.6 V, which differs slightly from the specification for VCC.
-  The boot screen is retransmitted on the USB port after the enumeration. However, messages generated between boot-up of the receiver and USB enumeration are not visible on the USB port.

V_USB needs to be powered by a separate LDO enabled by module VCC and supplied by the USB host.

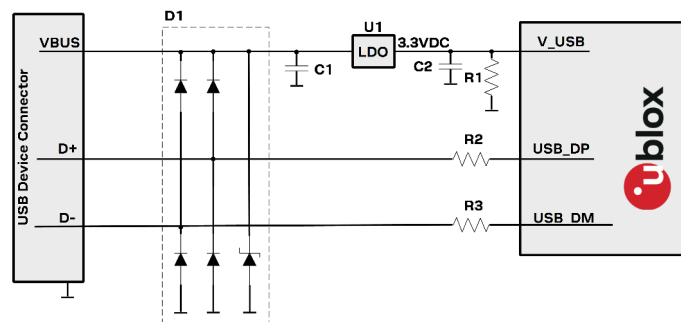

Figure 14: NEO-M9N example circuit for USB interface

Part	Recommended part	Description
U1	Seiko Instruments Inc. S-1206B33-I6T2G	LDO which provides 3.3 V to the V_USB pin.
C1, C2	Depends on USB LDO (U1) specification	U1 LDO decoupling capacitor.

Part	Recommended part	Description
D1	ST Microelectronics USBLC6-2	Low capacitance ESD protection diodes to avoid cross supply.
R1	100 kΩ	Pull-down resistor in case USB interface is not used. Not needed if USB is used.
R2, R3	27 Ω 5% 0.1W	Serial termination resistor for USB.

Table 12: Recommended components for USB interface

3.6 Predefined PIOs

In addition to the communication ports, there are some predefined PIOs provided by NEO-M9N to interact with the receiver. These PIOs are described in this chapter.

 Note that if hardware backup mode is used a proper isolation of the interfaces is needed. How to implement the isolation is described in the [Hardware backup](#) topic.

3.6.1 D_SEL

The D_SEL pin can be used to configure the functionality of the combined UART1, I2C, and SPI pins. It is possible to configure the pins as UART1 + I2C, or as SPI. SPI is not available unless D_SEL pin is set to low. See [Table 13](#) below.

Pin No	D_SEL == 0	D_SEL == 1
20	SPI_MISO	UART1 TXD
21	SPI_MOSI	UART1 RXD
18	SPI_CS_N	I2C SDA
19	SPI_CLK	I2C SCL

Table 13: D_SEL configuration

3.6.2 RESET_N

The NEO-M9N receiver provides the ability to reset the receiver. The RESET_N pin is an input-only pin with an internal pull-up resistor. Driving RESET_N low for at least 100 ms will trigger a cold start.

 The RESET_N pin will delete all information and trigger a cold start. It should only be used as a recovery option.

3.6.3 SAFEBOOT_N

The NEO-M9N receiver provides a SAFEBOOT_N pin that is used to command the receiver into safe boot mode.

If this pin is low at power up, the receiver starts in safe boot mode and GNSS operation is disabled.

The safe boot mode can be used to recover from situations where the flash content has become corrupted and needs to be restored.

In safe boot mode the receiver runs from a passive oscillator circuit with less accurate timing and hence the receiver is unable to communicate via USB.

In this mode only UART1 and I2C communication is possible. For communication via UART1 in safe boot mode, the host must send a training sequence (0 x 55 55 at 9600 baud) to the receiver in order to begin communication. After this the host must wait at least 2 ms before sending any data.

It is recommended to have the possibility to pull the SAFEBOOT_N pin low in the application. This can be provided using an externally connected test point or a host I/O port.

3.6.4 TIMEPULSE

The NEO-M9N standard precision GNSS receiver provides a time pulse on the TIMEPULSE pin.



More information about the time pulse feature, its possibilities and configuration can be found in [Time pulse](#).

3.6.5 TX_READY

This feature enables each port to define a corresponding pin, which indicates if bytes are ready to be transmitted. A listener can wait on the TX_READY signal instead of polling the I2C or SPI interfaces. The CFG-TXREADY message lets you configure the polarity and the number of bytes in the buffer before the TX_READY signal goes active. By default, this feature is disabled. For USB, this feature is configurable but might not behave as described below due to a different internal transmission mechanism. If the number of pending bytes reaches the threshold configured for this port, the corresponding pin will become active (configurable active-low or active-high), and stay active until the last bytes have been transferred from software to hardware.



This is not necessarily equal to all bytes transmitted, i.e. after the pin has become inactive, up to 16 bytes might still need to be transferred to the host.

The TX-READY pin can be selected from all PIOs which are not in use (see UBX-MON-HW3 in the NEO-M9N Interface description [2] for a list of the PIOs and their mapping). Each TX-READY pin is exclusively for one port and cannot be shared. If the PIO is invalid or already in use, only the configuration for the TX-READY pin is ignored, the rest of the port configuration is applied if valid. The acknowledge message does not indicate if the TX-READY configuration is successfully set, it only indicates the successful configuration of the port. To validate successful configuration of the TX-READY pin, the port configuration should be polled and the settings of TX-READY feature verified (will be set to disabled/all zero if the settings are invalid).

The threshold should not be set above 2 kB as it is possible that the internal message buffer limit is reached before this. This results in the TX-READY pin never being set as the messages are discarded before the threshold is reached.

3.6.5.1 Extended TX timeout

If the host does not communicate over SPI or I2C for more than approximately 2 seconds, the device assumes that the host is no longer using this interface and no more packets are scheduled for this port. This mechanism can be changed by enabling "extended TX timeouts", in which case the receiver delays idling the port until the allocated and undelivered bytes for this port reach 4 kB. This feature is especially useful when using the TX-READY feature with a message output rate of less than once per second, and polling data only when data is available, determined by the TX-READY pin becoming active.

3.6.6 EXTINT

EXTINT is an external interrupt pin with fixed input voltage thresholds with respect to VCC. It can be used for functions such as accurate external frequency aiding and on/off control. The external frequency aiding can be used to calibrate the clock. This enables faster fix of satellite signals (UBX-MGA-INI-FREQ or UBX-MGA-INI-TIME_XXX) and can be used during normal operation or during the production test. Another possibility to use the extint feature, is to wake-up the receiver after putting it into backup mode this can be set up with UBX-RXM-PMREQ. Leave open if unused, this function is disabled by default.



If the EXTINT pin is configured for on/off switching of the receiver, the internal pull-up becomes disabled. Thus make sure the EXTINT input is always driven within the defined voltage level by the host.

3.7 Multiple GNSS assistance (MGA)

The u-blox MGA services provide a proprietary implementation of an A-GNSS protocol compatible with u-blox GNSS receivers. When a client device makes an MGA request, the service responds with the requested data using UBX protocol messages. These messages are ready for direct transmission to the receiver communication port without requiring any modification by the client.

Currently, these MGA services consist of AssistNow Online and Offline, each delivered by the HTTP or HTTPS protocols.

In addition there is an MGA service called AssistNow Autonomous which does not need an internet connection and runs entirely on the receiver itself.

AssistNow Online optionally provides satellite ephemerides, health information and time aiding data suitable for GNSS receiver systems with direct internet access.

The AssistNow Offline service benefits u-blox GNSS receivers that only have occasional internet access. Users request data from the service by specifying the time period for which they want coverage (1 to 5 weeks).

The data downloaded from the service is organized by date and encoded into a sequence of UBX MGA messages.

Table 14 below contains an overview of the different MGA services u-blox provides.

	AssistNow Online	AssistNow Offline	AssistNow Autonomous
Requires external flash memory	No	Optional	Optional
Requires internet connection	Permanently	Sporadically	No
Amount of internet data	Medium	High	None
Ephemeris in data	Yes	No	No
Almanac in data	Yes	Yes	Yes

Table 14: AssistNow service overview

3.7.1 Authorization

The AssistNow Online Service is only available for use by u-blox customers. In order to use the services, customers will need to obtain an authorization token from u-blox. This token must be supplied as a parameter whenever a request is made to either service. Please contact your local technical support or go to <https://www.u-blox.com/en/solution/services/assistnow> to get more information and request an authorization token.

3.7.2 Multiple servers

u-blox has designed and implemented the AssistNow Online Service in a way that it provides very high reliability. Nonetheless, there will be rare occasions when a server is not available (e.g. due to failure or some form of maintenance activity). In order to protect customers against the impact of such outages, u-blox runs at least two instances of the AssistNow Online Service on independent machines. Customers have a choice of requesting assistance data from any of these servers, as all will provide the same information. However, should one fail for whatever reason, it is highly unlikely that the other server(s) will also be unavailable. Therefore customers requiring the best possible

availability are recommended to implement a scheme where they direct their requests to a chosen server, but, if that server fails to respond, have a fallback mechanism to use another server instead.

3.7.3 Preserving information during power-off

The performance of u-blox receivers immediately after they are turned on is enhanced by providing them with as much useful information as possible. AssistNow services are one way to achieve this, but retaining information from previous use of the receiver can be just as valuable. All the types of data delivered by assistance can be retained while the receiver is powered down for use when power is restored. Obviously the value of this data will diminish as time passes, but in many cases it remains very useful and can significantly improve time to first fix.

There are several ways in which a u-blox receiver can retain useful data while it is powered down, including:

- **Battery-backed RAM:** The receiver can be supplied with sufficient power to maintain a small portion of internal storage, while it is otherwise turned off. This is the best mechanism, provided that the small amount of electrical power required can be supplied continuously. V_BCKP is the pin to sustain battery-backed RAM.
- **Save-on-Shutdown:** The receiver can be instructed to dump its current state to flash memory as part of the shutdown procedure; this data is then automatically retrieved when the receiver is restarted. For more information, see the description of the UBX-UPD-SOS messages in the NEO-M9N Interface description [2].

3.7.4 AssistNow Online

AssistNow Online is u-blox's end-to-end Assisted GNSS (A-GNSS) solution for receivers that have access to the internet. Data supplied by the AssistNow Online Service can be directly uploaded to a u-blox receiver in order to substantially reduce time to first fix (TTFF), even under poor signal conditions (typically around 2 seconds; see NEO-M9N Data sheet [1] "Aided start"). The system works by collecting data such as ephemeris and almanac from the satellites through u-blox's "Global Reference Network" of receivers and providing this data to customers in a convenient form that can be forwarded directly to u-blox receivers.

The AssistNow Online Service uses a simple, stateless, HTTP interface. Therefore, it works on all standard mobile communication networks that support internet access, including GPRS, UMTS and Wireless LAN. No special arrangements need to be made with mobile network operators to enable AssistNow Online.

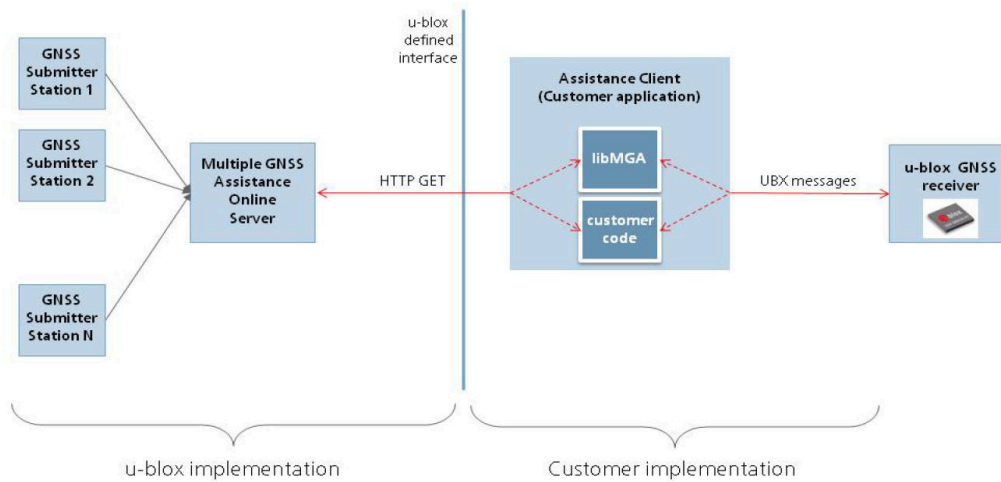

Figure 15: MGA architecture

The data returned by the AssistNow Online Service is a sequence of UBX-MGA messages, starting with an estimate of the current time in the form of a UBX-MGA-INITIME_UTC message.



AssistNow Online currently supports GPS, GLONASS, BeiDou, Galileo, and QZSS.



Customers may choose to use third party sources of assistance data instead of using the AssistNow Online Service. Customers choosing this option will need to ensure that the data is converted from the format used by the third party source to the appropriate MGA messages. However, it is important to ensure that the receiver has an estimate of the current time before it processes any other assistance data. For this reason, it is strongly recommended to send a UBX-MGA-INITIME_UTC or UBX-MGA-INITIME_GNSS as the first message of any assistance.

3.7.4.1 Host software

As u-blox receivers have no means to connect directly with the internet, the AssistNow Online system can only work if the host system that contains the receiver can connect to the internet, download the data from the AssistNow Online Service and forward it on to the receiver. In the simplest case that may involve fetching the data from the AssistNow Online Service (by means of a single HTTP or HTTPS GET request), and sending the resulting data to the receiver.

Depending on the circumstances, it may be beneficial for the host software to include:

- Creating an appropriate UBX-MGA-INITIME_UTC message to deliver a better estimation of the current time to the receiver, especially if the host system has a very good estimation of the current time and can deliver a time pulse to one of the receiver's EXTINT pins.
- Enable and use flow control to prevent loss of data due to buffer overflow in the receiver.



u-blox provides the source code for an example library, called libMGA, that provides all of the functionality we expect in most host software.

3.7.4.2 AssistNow Online sequence

A typical sequence of use of the AssistNow Online Service comprises the following steps:

- Power up the u-blox receiver.
- Request data from the AssistNow Online Service.

- Optionally send UBX-MGA-INI-TIME_UTC followed by hardware time synchronization pulse if hardware time synchronization is required.
- Send the UBX messages obtained from the AssistNow Online Service to the receiver.

3.7.4.3 Flow control

u-blox receivers aim to process incoming messages as quickly as possible, but there will always be a small delay in processing each message. Uploading assistance data to the receiver can involve sending as many as one hundred individual messages to the receiver, one after the other. If the communication link is fast, and/or the receiver is busy (trying to acquire new signals), it is possible that the internal buffers will overflow and some messages will be lost. In order to combat this, u-blox receivers support an optional flow control mechanism for assistance.

Flow control is activated by setting the CFG-NAVSPG-ACKAIDING configuration item. As a result the receiver will issue an acknowledgment message (UBX-ACK-ACK) for each assistance message it successfully receives. The host software can examine these acknowledgments to establish whether there were any problems with the data sent to the receiver and deduce (by the lack of acknowledgment) if any messages have been lost. It may then be appropriate to resend some of the assistance messages.

The simplest way to implement flow control would be to send one UBX-MGA message at a time, waiting for the acknowledgment, before sending the next. However, such a strategy is likely to introduce significant delays into the whole assistance process. The best strategy will depend on the amount of assistance data being sent and the nature of the communications link (e.g. baud rate of serial link). u-blox recommends that when customers are developing their host software they start by sending all assistance messages and then analyze the resulting acknowledgments to see if any messages have been lost. Adding small delays during the transmission may be a simple but effective way to avoid loss of data.

3.7.4.4 Service parameters

The information exchange with the AssistNow Online Service is based on the HTTPS protocol. Upon reception of an HTTPS GET request, the server will respond with the required messages in binary format or with an error string in text format. After delivery of all data, the server will terminate the connection.

The HTTPS GET request from the client to the server should contain a standard HTTPS query string in the request URL. The query string consists of a set of "key=value" parameters in the following form:

key=value;key=value;key=value;

The following rules apply:

- The order of keys is important.
- Keys and values are case-sensitive.
- Keys and values must be separated by an "equal" character ("=").
- Key/value pairs must be separated by semicolons (";").
- If a value contains a list, each item in the list must be separated by a comma (",").

The following table describes the keys that are supported:

Key name	Unit/range	Optional	Description
token	String	Mandatory	The authorization token supplied by u-blox when a client registers to use the service.
gnss	String	Mandatory	A comma-separated list of the GNSS for which data should be returned. Valid GNSS are: gps, gal, glo, bds and qzss (case-sensitive).

Key name	Unit/range	Optional	Description
datatype	String	Mandatory	A comma-separated list of the data types required by the client. Valid data types are: eph, alm, aux and pos. Time data is always returned for each request. If the value of this parameter is an empty string, only time data will be returned.
lat	Numeric [degrees]	Optional	Approximate user latitude in WGS 84 expressed in degrees and fractional degrees. Must be in range -90 to 90. Example: lat=47.2.
lon	Numeric [degrees]	Optional	Approximate user longitude in WGS 84 expressed in degrees and fractional degrees. Must be in range -180 to 180. Example: lon=8.55.
alt	Numeric [meters]	Optional	Approximate user altitude above WGS 84 Ellipsoid. If this value is not provided, the server assumes an altitude of 0 meters. Must be in range -1000 to 50000.
pacc	Numeric [meters]	Optional	Approximate accuracy of submitted position (see the Position parameters (lat, lon, alt and pacc) section below). If this value is not provided, the server assumes an accuracy of 300 km. Must be in range 0 to 6000000.
tacc	Numeric [seconds]	Optional	The timing accuracy (see the Time parameters (tacc and latency) section below). If this value is not provided, the server assumes an accuracy of 10 seconds. Must be in range 0 to 3600.
latency	Numeric [seconds]	Optional	Typical latency between the time the server receives the request, and the time when the assistance data arrives at the u-blox receiver. The server can use this value to correct the time being transmitted to the client. If this value is not provided, the server assumes a latency of 0. Must be in range 0 to 3600.
filteronpos	(no value required)	Optional	If present, the ephemeris data returned to the client will only contain data for the satellites which are likely to be visible from the approximate position provided by the lat, lon, alt and pacc parameters. If the lat and lon parameters are not provided the service will return an error.
filteronsv	String	Optional	A comma-separated list of u-blox gnssid:svId pairs. The ephemeris data returned to the client will only contain data for the listed satellites.

Table 15: AssistNow Online parameter keys

Thus, as an example, a valid parameter string would be:

```
token=XXXXXXXXXXXXXXXXXXXXXXXXX;gnss=gps,qzss;datatype=eph,pos,aux;lat=47.28;lon=8.56;pacc=1000
```

3.7.4.4.1 Position parameters (lat, lon, alt and pacc)

The position parameters (lat, lon, alt and pacc) are used by the server for two purposes:

- If the filteronpos parameter is provided, the server determines the currently visible satellites at the user position, and only sends the ephemeris data of those satellites which should be in view at the location of the user. This reduces bandwidth requirements. In this case the "pacc" value is taken into account, meaning that the server will return all SVs visible in the given uncertainty region.
- If the datatype "pos" is requested, the server will return the position and accuracy in the response data. When this data is supplied to the u-blox receiver, depending on the accuracy of the provided data, the receiver can then choose to select a better startup strategy. For example, if the position is accurate to 100 km or better, the u-blox receiver will choose to go for a more optimistic startup strategy. This will result in quicker startup time. The receiver will decide which strategy to choose, depending on the "pacc" parameter. If the submitted user position is less accurate than what is being specified with the "pacc" parameter, then the user will experience prolonged or even failed startups.

3.7.4.4.2 Time parameters (tacc and latency)

Time data is always returned with each request. The time data refers to the time at which the response leaves the server, corrected by an optional latency value. This time data provided by the service is accurate to approximately 10 ms but by default the time accuracy is indicated to be +/-10 seconds in order to account for network latency and any time between the client receiving the data and it being provided to the receiver.

If both the network latency and the client latency can safely be assumed to be very low (or are known), the client can choose to set the accuracy of the time message (tacc) to a much smaller value (e.g. 0.5 s). This will result in a faster TTFF. The latency can also be adjusted as appropriate. However, these fields should be used with caution: if the time accuracy is not correct when the time data reaches the receiver, the receiver may experience prolonged or even failed startups.

For optimal results, the client should establish an accurate sense of time itself (e.g. by calibrating its system clock using a local NTP service) and then modify the time data received from the service as appropriate.

3.7.5 AssistNow Offline

AssistNow Offline is a feature that combines special firmware in u-blox receivers and a proprietary service run by u-blox. It is targeted at receivers that only have occasional internet access and so cannot use AssistNow Online. AssistNow Offline speeds up Time To First Fix (TTFF), typically to considerably less than 10 s.



AssistNow Offline currently supports GPS and GLONASS. u-blox intends to expand the AssistNow Offline Service to support other GNSS (such as BeiDou and Galileo) in due course.

The AssistNow Offline Service uses a simple, stateless, HTTP interface. Therefore, it works on all standard mobile communication networks that support internet access, including GPRS, UMTS and Wireless LAN. No special arrangements need to be made with mobile network operators to enable AssistNow Offline.

Users of AssistNow Offline are expected to download data from the AssistNow Offline Service, specifying the time period they want covered (1 day to 5 weeks) and the types of GNSS. This data must be uploaded to a u-blox receiver, so that it can estimate the positions of the satellites, when no better data is available. Using these estimates will not provide as accurate a position fix as if current ephemeris data is used, but it will allow much faster TTFFs in nearly all cases.

The data obtained from the AssistNow Offline Service is organized by date, normally a day at a time. Consequently the longer time for which coverage is requested, the larger the amount of data to handle. Similarly, each different GNSS requires its own data and in the extreme cases, several hundred kilobytes of data will be provided by the service. This amount can be reduced by requesting lower resolution, but this will have a small negative impact on both position accuracy and TTFF. See the section on [Offline Service Parameters](#) for details of how to specify these options.

The downloaded Offline data is encoded in a sequence of UBX-MGA-ANO messages, one for every SV for every day of the period covered. Thus, for example, data for all GPS SVs for 4 weeks will involve in excess of 900 separate messages, taking up around 70 Kbytes. Where a u-blox receiver has flash storage, all the data can be directly uploaded to be stored in the flash until it is needed. In this case, the receiver will automatically select the most appropriate data to use at any time. See the section on [flash-based AssistNow Offline](#) for further details.

AssistNow Offline can also be used where the receiver has no flash storage, or there is insufficient spare flash memory. In this case the customer's system must store the AssistNow Offline data until the receiver needs it and then upload only the appropriate part for immediate use. See the section on [host-based AssistNow Offline](#) for further details.

3.7.5.1 Service parameters

The information exchange with the AssistNow Offline Service is based on the HTTP protocol. Upon reception of an HTTP GET request, the server will respond with the required messages in binary format or with an error string in text format. After delivery of all data, the server will terminate the connection.

The HTTP GET request from the client to the server should contain a standard HTTP querystring in the request URL. The querystring consists of a set of "key=value" parameters in the following form:

key=value;key=value;key=value;

The following rules apply:

- The order of keys is not important.
- Keys and values are case-sensitive.
- Keys and values must be separated by an equals character ('=').
- Key/value pairs must be separated by semicolons(';').
- If a value contains a list, each item in the list must be separated by a comma(',').

The following table describes the keys that are supported.

Key Name	Unit/Range	Optional	Description
token	String	Mandatory	The authorization token supplied by u-blox when a client registers to use the service.
gnss	String	Mandatory	A comma-separated list of the GNSS for which data should be returned. The currently supported GNSS are: gps and glo.
period	Numeric [weeks]	Optional	The number of weeks into the future the data should be valid for. Data can be requested for up to 5 weeks in to the future. If this value is not provided, the server assumes a period of 4 weeks.
days	Numeric [days]	Optional	The number of days into the future the data should be valid for. Can be used instead of the period parameter when data for less than one week is desired.
resolution	Numeric [days]	Optional	The resolution of the data: 1=every day, 2=every other day, 3=every third day. If this value is not provided, the server assumes a resolution of 1 day.

Table 16: AssistNow Offline parameter keys

Thus, as an example, a valid parameter string would be:

token=XXXXXXXXXXXXXXXXXXXXX;gnss=gps,glo;

3.7.5.2 Time, position and almanac

While AssistNow Offline can be used on its own, it is expected that the user will provide estimates of the receiver's current position, the current time and ensure that a reasonably up-to-date almanac is available. In most cases this information is likely to be available without the user needing to do anything. For example, where the receiver is connected to a battery backup power supply and has a functioning real time clock (RTC), the receiver will keep its own sense of time and will retain the last known position and any almanac. However, should the receiver be completely unpowered before startup, then it will greatly improve TTFF if time, position and almanac can be supplied in some form.

Almanac data has a validity period of several weeks, so it can be downloaded from the AssistNow Online service at roughly the same time the Offline data is obtained. It can then be stored in the host for uploading on receiver startup, or it can be transferred to the receiver straight away and preserved there (provided suitable non-volatile storage is available).

Obviously, where a receiver has a functioning RTC, it should be able to keep its own sense of time, but where no RTC is fitted (or power is completely turned off), providing a time estimate via the UBX-MGA-INI-TIME_UTC message will be beneficial to lower the time to first fix and make use of the AssistNow Offline data.

Similarly, where a receiver has effective non-volatile storage, the last known position will be recalled, but if this is not the case, then it will help TTFF to provide a position estimate via one of the UBX-MGA-INI-POS_XYZ or UBX-MGA-INI-POS_LLLH messages (details can be found in NEO-M9N Interface description [2]).

Where circumstance prevent the provision of all three of these pieces of data, providing some is likely to be better than none at all, as this helps to lower the TTFF.

3.7.5.3 Flash-based AssistNow Offline

Flash-based AssistNow Offline functionality means that AssistNow Offline data is stored in the flash memory connected to the chip.

The user's host system must download the data from the AssistNow Offline service when an internet connection is available, and then deliver all of that data to the u-blox receiver. As the total amount of data to be uploaded is large (typically around 100 kbytes) and writing to flash memory is slow, the upload must be done in blocks of up to 512 bytes, one at a time. The UBX-MGA-FLASH-DATA message is used to transmit each block to the receiver.



AssistNow Offline data stored in flash memory is not affected by any reset of the receiver. The only simple ways to clear it are to completely erase the whole flash memory or to overwrite it with a new set of AssistNow Offline data. Uploading a dummy block of data (e.g. all zeros) will also have the effect of deleting the data, although a small amount of flash storage will be used.

3.7.5.3.1 Flash-based storage procedure

The following steps are a typical sequence for transferring AssistNow Offline data into the receiver's flash memory:

- The host downloads a copy of a latest data from the AssistNow Offline service and stores it locally.
- It sends the first 512 bytes of that data using the UBX-MGA-FLASH-DATA message.
- It awaits a UBX-MGA-FLASH-ACK message in reply.
- Based on the contents of the UBX-MGA-FLASH-ACK message it sends the next block, resends the last block or aborts the whole process.
- The above three steps are repeated until all the rest of the data has been successfully transferred (or the process has been aborted).
- The host sends an UBX-MGA-FLASH-STOP message to indicate completion of the upload.
- It awaits the final UBX-MGA-FLASH-ACK message in reply. Background processing in the receiver prepares the downloaded data for use at this stage. Particularly if the receiver is currently busy, this may take quite a few seconds, so the host has to be prepared for a delay before the UBX-MGA-FLASH-ACK is seen.

Note that the final block may be smaller than 512 bytes (where the total data size is not perfectly divisible by 512). Also, the UBX-MGA-FLASH-ACK messages are distinct from the UBX-MGA-ACK messages used for other AssistNow functions.

Any existing data will be deleted as soon as the first block of new data arrives, so no useful data will be available till the completion of the data transfer. Each block of data has a sequence number, starting at zero for the first block. In order to guard against invalid partial data downloads the receiver will not accept blocks which are out of sequence.

3.7.5.4 Host-based AssistNow Offline

Host-based AssistNow Offline involves AssistNow Offline data being stored until it is needed by the user's host system in whatever memory it has available.

The user's host system must download the data from the AssistNow Offline service when an internet connection is available, but retain it until the time the u-blox receiver needs it. At this point, the host must upload just the relevant portion of the data to the receiver, so that the receiver can start using it. This is achieved by parsing all the data and selecting for upload to the receiver only those UBX-MGA-ANO messages with a date-stamp nearest the current time. As each is a complete

UBX message it can be sent directly to the receiver with no extra packaging. If required the user can select to employ flow control, but in most cases this is likely to prove unnecessary.

When parsing the data obtained from the AssistNow Offline service the following points should be noted:

- The data is made up of a sequence of UBX-MGA-ANO messages.
- Customers should not rely on the messages all being of fixed size, but should read their length from the UBX header to work out where the message ends (and where the next begins).
- Each message indicates the SV for which it is applicable through the `svId` and `gnssId` fields.
- Each message contains a date-stamp within the year, month and day fields.
- Midday (UTC) on the day indicated should be considered to be the point at which the data is most applicable.
- The messages will be ordered chronologically, earliest first.
- Messages with same date-stamp will be ordered by ascending `gnssId` and then ascending `svId`.

3.7.5.4.1 Host-based procedure

The following steps are a typical sequence for host-based AssistNow Offline:

- The host downloads a copy of the latest data from the AssistNow Offline service and stores it locally.
- Optionally it may also download a current set of almanac data from the AssistNow Online service.
- The host wants to use the u-blox receiver.
- If necessary it uploads any almanac, position estimate and/or time estimate to the receiver.
- It scans through AssistNow Offline data looking for entries with a date-stamp that most closely matches the current (UTC) time/date.
- The host sends each such UBX-MGA-ANO message to the receiver.

Note that when data has been downloaded from the AssistNow Offline service with the (default) resolution of one day, the means for selecting the closest matching date-stamp is simply to look for ones with the current (UTC) date.

3.7.6 AssistNow Autonomous

3.7.6.1 Introduction

The assistance scenarios covered by *AssistNow Online* and *AssistNow Offline* require an online connection and a host that can use this connection to download aiding data and provide this to the receiver when required.

The *AssistNow Autonomous* feature provides a functionality similar to *AssistNow Offline* without the need for a host and a connection. Based on a broadcast ephemeris downloaded from the satellite (or obtained by *AssistNow Online*) the receiver can autonomously (i.e. without any host interaction or online connection) generate an accurate satellite orbit representation («AssistNow Autonomous data») that is usable for navigation much longer than the underlying broadcast ephemeris was intended for. This makes downloading new ephemeris or aiding data for the first fix unnecessary for subsequent start-ups of the receiver.



The *AssistNow Autonomous* feature is disabled by default. It can be enabled using the CFG-ANA group (item `USE_ANA` to activate AOP).

3.7.6.2 Concept

The figure below illustrates the *AssistNow Autonomous* concept in a graphical way. Note that the figure is a qualitative illustration and is not to scale.

- A broadcast ephemeris downloaded from the satellite is a precise representation of a part (for GPS nominally four hours) of the satellite's true orbit (trajectory). It is not usable for positioning beyond this validity period because it diverges dramatically from the true orbit afterwards.
- The *AssistNow Autonomous orbit* is an extension of one or more broadcast ephemerides. It provides a long-term orbit for the satellite for several revolutions. Although this orbit is not perfectly precise it is a sufficiently accurate representation of the true orbit to be used for navigation.
- The *AssistNow Autonomous data* is automatically and autonomously generated from downloaded (or assisted) ephemerides. The data is stored automatically in the on-chip battery-backed memory (BBR). Optionally, the data can be backed up in external flash memory or on the host. The number of satellites for which data can be stored depends on the receiver configuration and may change during operation.
- If no broadcast ephemeris is available for navigation *AssistNow Autonomous* automatically generates the required parts of the orbits suitable for navigation from the stored data. The data is also automatically kept current in order to minimize the calculation time once the navigation engine needs orbits.
- The operation of the *AssistNow Autonomous* feature is transparent to the user and the operation of the receiver. All calculations are done in the background and do not affect the normal operation of the receiver.
- The *AssistNow Autonomous* subsystem automatically invalidates data that has become too old and that would introduce unacceptable positioning errors. This threshold is configurable.
- The prediction quality will be automatically improved if the satellite has been observed multiple times. However, this requires the availability of a suitable flash memory (see the NEO-M9N Interface description [2] for a list of supported devices). Improved prediction quality also positively affects the maximum usability period of the data.
- *AssistNow Autonomous* considers GPS, GLONASS, Galileo and BeiDou satellites only. It will not consider satellites on orbits with an eccentricity of >0.05 (e.g., Galileo E18). For GLONASS support a suitable flash memory is mandatory because a single broadcast ephemeris spans too little time of the orbit (only approx. 30 minutes) in order to extend it in a usable way. Only multiple observations of the same GLONASS satellite that span at least four hours will be used to generate data.

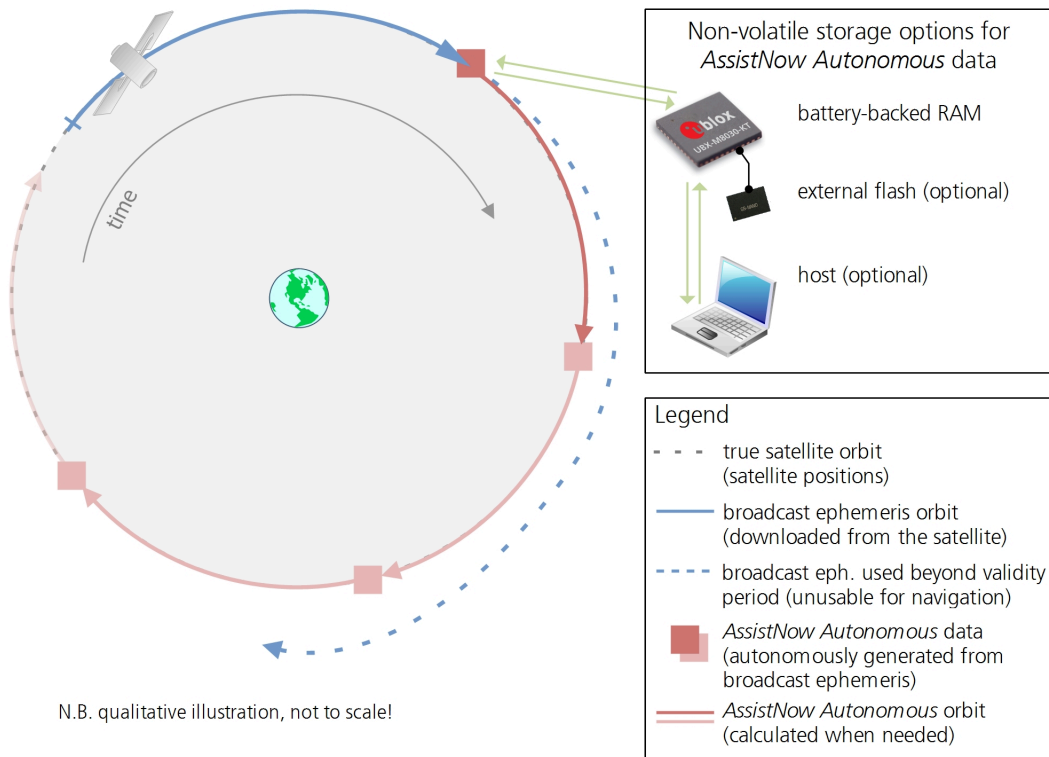

3.7.6.3 Interface

Several UBX protocol messages provide interfaces to the *AssistNow Autonomous* feature. They are:

- The CFG-ANA-USE_ANA item is used to enable or disable the *AssistNow Autonomous* feature. It is disabled by default. Once enabled, the receiver will automatically produce *AssistNow Autonomous* data for newly received broadcast ephemerides and, if that data is available, automatically provide the navigation subsystem with orbits when necessary and adequate. The message also allows for a configuration of the maximum acceptable orbit error. See the next section for an explanation of this feature. It is recommended to use the firmware default value that corresponds to a default orbit data validity of approximately three days (for GPS satellites observed once) and up to six days (for GPS and GLONASS satellites observed multiple times over a period of at least half a day).
- Note that disabling the *AssistNow Autonomous* feature will delete all previously collected satellite observation data from the flash memory.
- The UBX-NAV-AOPSTATUS message provides information on the current state of the *AssistNow Autonomous* subsystem. The status indicates whether the *AssistNow Autonomous* subsystem is currently idle (or not enabled) or busy generating data or orbits. Hosts should monitor this information and only power off the receiver when the subsystem is idle (that is, when the `status` field shows a steady zero).
- The UBX-NAV-SAT message indicates the use of *AssistNow Autonomous* orbits for individual satellites.
- The UBX-NAV-ORB message indicates the availability of *AssistNow Autonomous* orbits for individual satellites.
- The UBX-MGA-DBD message provides a means to retrieve the *AssistNow Autonomous* data from the receiver in order to preserve the data in power-off mode where no battery backup is available. Note that the receiver requires the absolute time (i.e. full date and time) to calculate *AssistNow Autonomous* orbits. For best performance it is, therefore, recommended to supply this information to the receiver using the UBX-MGA-INI-TIME_UTC message in this scenario.

- The Save-on-Shutdown feature preserves *AssistNow Autonomous* data (more information about the SoS feature: NEO-M9N Interface description [2]).

3.7.6.4 Benefits and drawbacks

AssistNow Autonomous can provide quicker start-up times (lower the TTFF) provided that data is available for enough visible satellites. This is particularly true under weak signal conditions where it might not be possible to download broadcast ephemerides at all, and, therefore, no fix at all would be possible without *AssistNow Autonomous* (or A-GNSS). It is, however, required that the receiver roughly knows the absolute time, either from an RTC or from time-aiding (see the *Interface* section above), and that it knows which satellites are visible, either from the almanac or from tracking the respective signals.

The *AssistNow Autonomous* orbit (satellite position) accuracy depends on various factors, such as the particular type of satellite, the accuracy of the underlying broadcast ephemeris, or the orbital phase of the satellite and Earth, and the age of the data (errors add up over time).

AssistNow Autonomous will typically extend a broadcast ephemeris from three up to six days. The CFG-ANA-ORBMAXERR item allows changing this threshold by setting the «maximum acceptable modeled orbit error» (in meters). Note that this number does not reflect the true orbit error introduced by extending the ephemeris. It is a statistical value that represents a certain expected upper limit based on a number of parameters. A rough approximation that relates the maximum extension time to this setting is: $maxError [m] = maxAge [d] * f$, where the factor f is 30 for data derived from satellites seen once and 16 for data derived for satellites seen multiple time during a long enough time period (see the [Concept](#) section above).

There is no direct relation between (true and statistical) orbit accuracy and positioning accuracy. The positioning accuracy depends on various factors, such as the satellite position accuracy, the number of visible satellites, and the geometry (DOP) of the visible satellites. Position fixes that include *AssistNow Autonomous* orbit information may be significantly worse than fixes using only broadcast ephemerides. It might be necessary to adjust the limits of the navigation output filters (CFG-NAV-OUTFIL_XXXX).

A fundamental deficiency of any system that prevents them from precise satellite orbit predictions, are the unknown future events. Hence, the receiver will not be able to know about satellites that will have become unhealthy, have undergone a clock swap, or have had a manoeuvre. This means that the navigation engine might rarely mistake a wrong satellite position as the true satellite position. However, provided that there are enough other good satellites, the navigation algorithms will eventually eliminate a defective orbit from the navigation solution.

The repeatability of the satellite constellation is a potential pitfall for the use of the *AssistNow Autonomous* feature. For a given location on Earth the (GPS) constellation (geometry of visible satellites) repeats every 24 hours. Hence, when the receiver «learned» about a number of satellites at some point in time the same satellites will in most places *not* be visible 12 hours later, and the available *AssistNow Autonomous* data will not be of any help. Again 12 hours later, however, usable data would be available because it was generated 24 hours ago.

The longer a receiver observes the sky the more satellites it will have seen. At the equator, and with full sky view, approximately ten (GPS) satellites will show up in a one-hour window. After four hours of observation approx. 16 satellites (i.e. half the constellation), after 10 hours approx. 24 satellites (2/3rd of the constellation), and after approx. 16 hours the full constellation will have been observed (and *AssistNow Autonomous* data generated for). Lower sky visibility reduces these figures. Further away from the equator the numbers improve because the satellites can be seen twice a day. For

example at 47 degrees north the full constellation can be observed in approx. 12 hours with full sky view.

The calculations required for *AssistNow Autonomous* are carried out on the receiver. This requires energy and users may therefore occasionally see increased power consumption during short periods (several seconds, rarely more than 60 seconds) when such calculations are running. Ongoing calculations will automatically prevent the power save mode from entering the power-off state. The power-down will be delayed until all calculations are done.



AssistNow Autonomous can be enabled if the system has sporadic access to the AssistNow Offline service. In this case the receiver will intelligently choose the more reliable orbit predictions for each satellite. This way the autonomous prediction can provide performance improvements if the offline data grows old or gets outdated.

3.7.7 Save-on-Shutdown feature

The Save-on-Shutdown feature (SOS) enables the u-blox receiver to store the contents of the battery-backed RAM to external flash memory and restore it upon startup. This allows the u-blox receiver to preserve some of the features available only with a battery backup (preserving configuration, IMU calibration, and satellite orbit knowledge) without having a battery backup supply present. It does not, however, preserve any kind of time knowledge. Save-on-Shutdown must be commanded by the host. The restoring of data on startup is automatically done if the corresponding data is present in the flash. No expiration check of the data is done.

The following outlines the suggested shutdown procedure when using the Save-on-Shutdown feature:

- With the UBX-CFG-RST message, the host commands the u-blox receiver to stop, specifying reset mode 0x08 ("Controlled GNSS stop") and a BBR mask of 0 ("Hotstart").
- The u-blox receiver confirms the reception of a valid / invalid request with a UBX-ACK-ACK / UBX-ACK-NAK message.
- The host commands the saving of the contents of BBR to the flash memory using the UBX-UPD-SOS-BACKUP message.
- The u-blox receiver confirms the reception of a valid / invalid request with a UBX-ACK-ACK / UBX-ACK-NAK message.
- For a valid request the u-blox receiver reports on the success of the backup operation with a UBX-UPD-SOS-ACK message.
- The host powers off the u-blox receiver.

And consequently the startup procedure is as follows:

- The host powers on the u-blox receiver.
- The u-blox receiver detects the previously stored data in flash. It restores the corresponding memory and reports the success of the operation with a UBX-UPD-SOS-RESTORED message on the port on which it had received the save command message (if the output protocol filter on that port allows it). It does not report anything if no stored data has been detected.
- Additionally the u-blox receiver outputs a UBX-INF-NOTICE and/or a NMEA-TXT message with the contents `RESTORED` in the boot screen (depends on the configuration of the port and information messages) upon success.
- Optionally the host can deliver coarse time assistance using UBX-MGA-INIT-TIME_UTC for better startup performance.

Once the u-blox receiver has started up it is suggested to delete the stored data using a UBX-UPD-SOS-CLEAR message. The u-blox receiver responds with a UBX-ACK-ACK / UBX-ACK-NAK message.

3.8 Power management

u-blox receivers support different power modes. These modes represent strategies of how to control the acquisition and tracking engines in order to achieve either the best possible performance or good performance with reduced power consumption.

Receiver power management can be split into two categories:

- **Externally controlled power management:** This includes various modes of power management that are directly operated by the user or host device. These modes are:
 1. External cycling of the receiver main power supply
 2. Instruct the receiver to turn on/off via the UBX-RXM-PMREQ message
 3. Instruct the receiver to turn on/off via external pins (EXTINT0 or EXTINT1)
- **Internally controlled power management:** Here the receiver makes the decision when to power down/up some/all of its internal components according to predefined parameters. It is also referred to as power save mode (PSM). In PSM one of two modes of operations can be selected:
 1. On/off operation (PSMOO)
 2. Cyclic tracking (PSMCT)

	Continuous operation	Cyclic operation	On/off operation
Main use	Continuous position tracking	Low-power continuous position tracking	Occasional position tracking
Possible applications	Navigation applications	Tracking devices with battery	Tracking devices which only need a position fix every few minutes or less

Table 17: Different power management modes

The following figure illustrates u-blox power management modes.

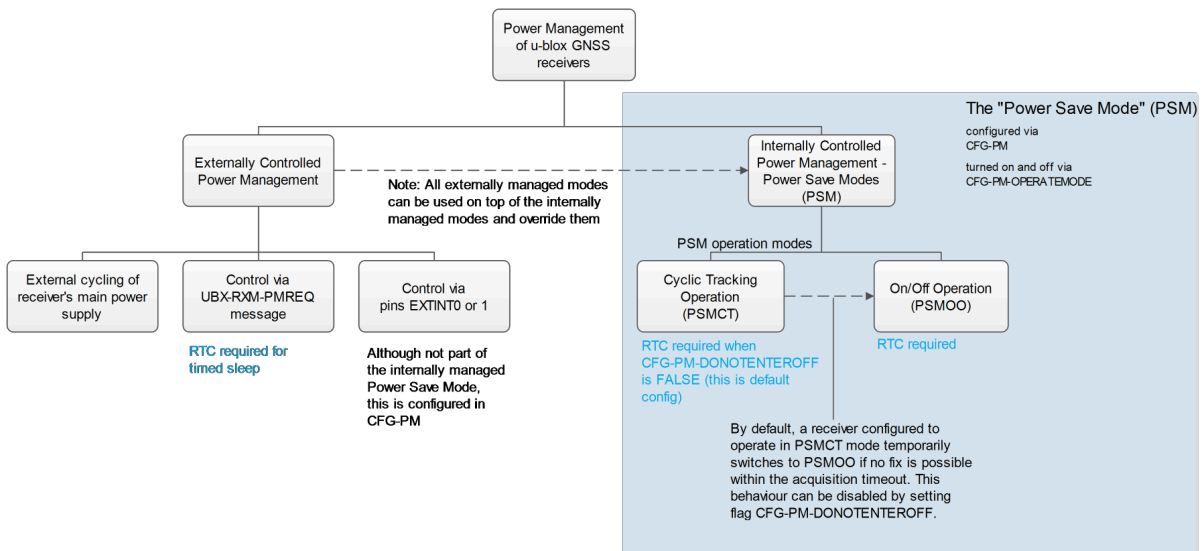

Figure 16: u-blox power management

The majority of the power management section explains the power save mode (internally controlled power management). However, some concepts relevant to the externally controlled power management are also explained, such as the [EXTINT control](#), [Wake up](#) and [Power on/off command](#).

Externally controlled power management operations override the internally controlled power management operations.

3.8.1 Continuous mode

u-blox receivers make use of dedicated signal processing engines optimized for signal acquisition and tracking. The acquisition engine delivers rapid signal searches during cold starts or when insufficient signals are available for navigation. The tracking engine delivers signal measurements for navigation and acquires new signals as they become available during navigation. The resources of both engines are deployed adaptively to minimize overall power consumption.

Note that even if the acquisition engine is powered off, satellites continue to be acquired.

3.8.2 Power save mode

Power save mode (PSM) allows a reduction in system power consumption by selectively switching parts of the receiver on and off. It is selected with CFG-PM-OPERATEMODE and configured with items in the CFG-PM group.

PSM is designed to only support the operation of GPS, GLONASS, BeiDou, Galileo and QZSS. Enabling SBAS is possible only if at least one of the other systems is enabled. The PSM state machine behavior will not be altered by enabling SBAS and it will not take them into account in operation. Therefore, it is recommended to disable SBAS when operating in power save mode. They can be disabled in the CFG-SIGNAL group.



The logic within power save mode is designed so that time pulse operation is not compromised. This means that entering all power saving states is delayed until the conditions necessary to produce a time pulse have been met. Therefore, in order to obtain good power save mode operation, it is essential that any time pulse is correctly configured with an appropriate time base, or that time pulses are turned off if not needed (by disabling the *TPX_ENA* item in the CFG-TP group).

3.8.2.1 Operation

Power save mode has two modes of operation:

- *Power save mode cyclic tracking (PSMCT) operation* is used when position fixes are required in short periods of 0.5 to 10 s.
- *Power save mode on/off (PSMOO) operation* is used for periods longer than 10 s, and can be in the order of minutes, hours or days.

The mode of operation can be configured, and depending on the setting, the receiver demonstrates different behavior: In on/off operation the receiver switches between phases of start-up/navigation and phases with low or almost no system activity (backup/sleep). In cyclic tracking the receiver does not shut down completely between fixes, but uses low power tracking instead.

Currently PSMCT is restricted to an update period between 0.5 and 10 seconds and PSMOO is restricted to an update period over 10 seconds. However, this may change in future firmware releases.

PSM is based on a state machine with five different states: *(Inactive) awaiting next fix* and *(Inactive) awaiting next search* states, *Acquisition* state, *Tracking* state and *power optimized tracking (POT)* state.

- *Inactive* states: Most parts of the receiver are switched off.
- *Acquisition* state: The receiver actively searches for and acquires signals. Maximum power consumption.

- *Tracking* state: The receiver continuously tracks and downloads data. Less power consumption than in *Acquisition* state.
- *POT* state: The receiver repeatedly loops through a sequence of tracking (Track), calculating the position fix (Fix), and entering an idle period (Idle). No new signals are acquired and no data is downloaded. Much less power consumption than in *Tracking* state.

The following figure illustrates the PSM state machine:

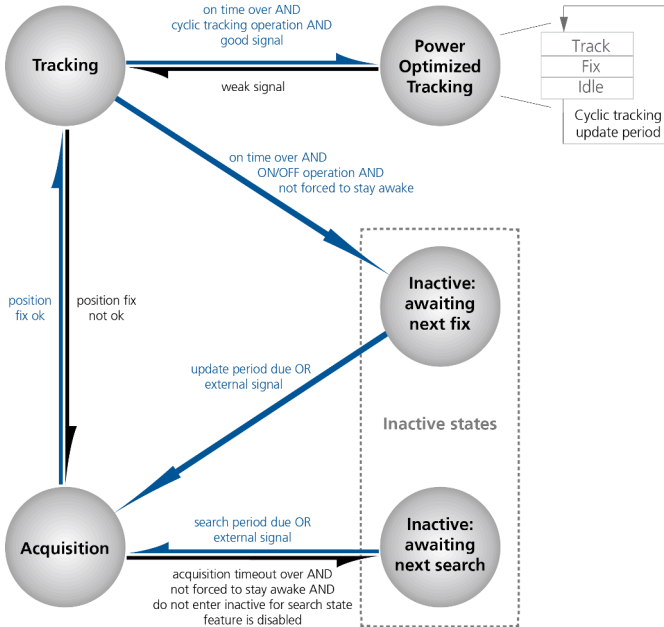

Figure 17: State machine

3.8.2.1.1 Acquisition timeout logic

The receiver has internal, external and user-configurable mechanisms that determine the time to be spent in acquisition state. This logic is put in place to ensure good performance and low power consumption in different environments and scenarios. This collective logic is referred to as Acquisition timeout.

Internal mechanisms:

- If the receiver is able to acquire weak signals but not of the quality needed to get a fix, it will transition to (*Inactive*) *awaiting next search* state after the timeout configured in *MAXACQTIME* or earlier if too few signals are acquired.
- If the receiver is unable to acquire any signals or it acquires a small number of extremely bad signals (e.g., no sky view), it will transition to (*Inactive*) *awaiting next search* state after 15 seconds or the timeout configured in *MAXACQTIME* if shorter.

User-configurable mechanisms:

- *MINACQTIME* is the minimum time that the receiver will spend in *Acquisition* state (see [MINACQTIME](#) for details.)
- *MAXACQTIME* is the maximum time that the receiver will spend in *Acquisition* state (see [MAXACQTIME](#) for details).
- *DONOTENTEROFF* forces the receiver to stay awake and in *Acquisition* state even when a fix is not possible (see [DONOTENTEROFF](#) for details).

External mechanisms:

- The receiver will be forced to stay awake if *EXTINTWAKE* is enabled and the configured EXTINT pin is set to "high" and it will be forced to stay in *(Inactive) awaiting next search/Fix* states if *EXTINTBACKUP* is enabled and the configured EXTINT pin is set to "low" (see [EXTINT pin control](#) for details).
- The receiver will be forced to stay awake if *EXTINTINACTIVE* is enabled and the configured EXTINT is toggling and it will be forced to stay in *(Inactive) awaiting next search/Fix* states if configured EXTINT state is not changed for longer time than *EXTINTINACTIVITY* (see [EXTINT pin control](#) for details).

3.8.2.1.2 On/off operation - long update period

The diagram below illustrates how on/off operation works:

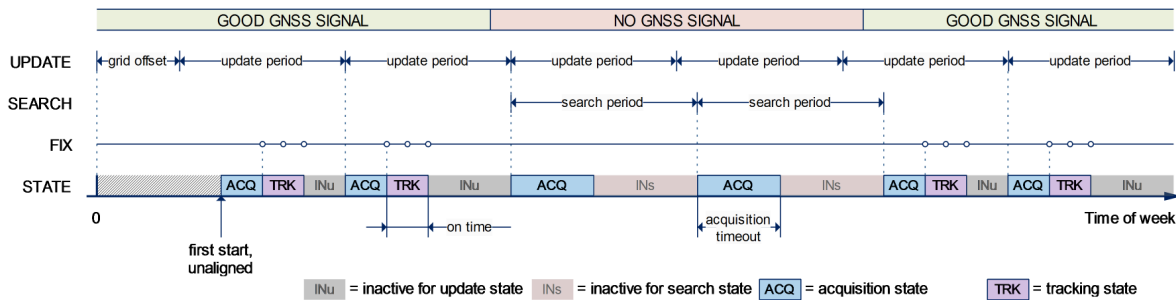

Figure 18: Diagram of on/off operation

- When the receiver is switched on, it first enters *Acquisition* state.
- If it is able to obtain a valid position fix within the time given by the [Acquisition Timeout](#), it switches to *Tracking* state. Otherwise it enters *(Inactive) awaiting next search* state and re-starts after the configured search period (minus a start-up margin).
- As soon as the receiver gets a valid position fix (one passing the navigation output filters), it enters *Tracking* state. Upon entering *Tracking* state, the [ONTIME](#) starts.
- Once the [ONTIME](#) is over, *(Inactive) awaiting next fix* state is entered and the receiver re-starts according to the configured update grid (see section [Grid offset](#) for an explanation).
- If the signal is lost while in *Tracking* state, *Acquisition* state is entered. If the signal is not found within the acquisition timeout, the receiver enters *(Inactive) awaiting next search* state. Otherwise the receiver will re-enter *Tracking* state and stay there until the newly started [ONTIME](#) is over.

3.8.2.1.3 Cyclic tracking operation - short update period

The diagram below illustrates how cyclic tracking operation works:

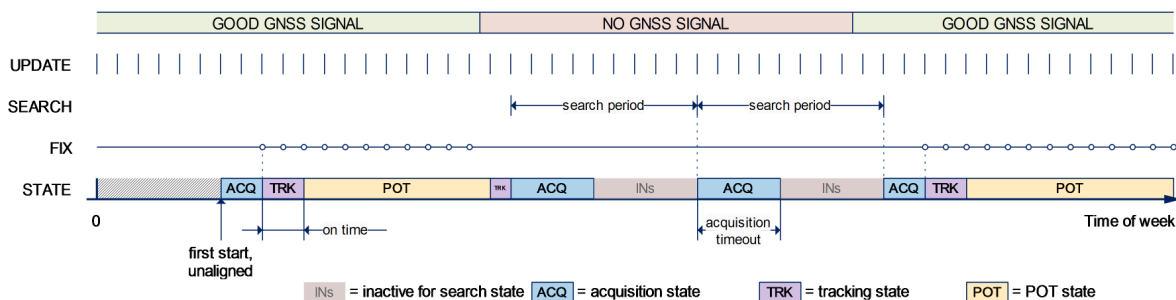

Figure 19: Diagram of cyclic tracking operation

- When the receiver is switched on, it first enters *Acquisition* state.
- If it is able to obtain a position fix within the time given by the acquisition timeout, it switches to *Tracking* state. Otherwise, it will enter *(Inactive) awaiting next search* state and re-start within the configured search grid.

- After a valid position fix, *Tracking* state is entered and the *ONTIME* starts. In other words the *ONTIME* starts with the first valid position fix.
- Once the *ONTIME* is over, *POT* state is entered.
- In *POT* state the receiver continues to output position fixes according to the *CFG-RATE*-.*. To have maximum power savings, set the *ONTIME* to zero. This causes the receiver to enter *POT* state as soon as possible.
- If the signal becomes weak or is lost during *POT* state, *Tracking* state is entered.
- Once the signal is good again and the newly started *ONTIME* is over, the receiver will re-enter *POT* state.
- If the receiver cannot get a position fix in the *Tracking* state, it enters *Acquisition* state. Should the acquisition fail as well, (*Inactive*) *awaiting next search* state is entered. If *DONOTENTEROFF* is enabled and no fix is possible, the receiver will remain in *Acquisition* state until a fix is possible and it will never enter (*Inactive*) *awaiting next search* state.

3.8.2.1.4 User-controlled operation - update and search period of zero

Setting the *CFG-PM-POSUPDATEPERIOD* to zero causes the receiver to wait in the (*Inactive*) *awaiting next fix* state until woken up by the user. Setting the search period to zero causes the receiver to wait in the (*Inactive*) *awaiting next search* state indefinitely after an unsuccessful start-up. Any wake-up event will re-start the receiver. See section [Wake up](#) for more information on wake-up events.



External wake-up is required when setting update or search period to zero.

3.8.2.1.5 Satellite data download

The receiver is not able to download satellite data (e.g. the ephemeris) while it is working in on/off or cyclic tracking operation. Therefore it has to temporarily switch to continuous operation for the time the satellites transmit the desired data. To save power the receiver schedules the downloads according to an internal timetable and only switches to continuous operation while data of interest is being transmitted by the satellites.

Each satellite transmits its own ephemeris data. Ephemeris data download is feasible when the corresponding satellite has been tracked with a sufficient C/N0 over a certain period of time. The download is scheduled in a 30-minute grid or immediately when fewer than a certain number of visible satellites have valid ephemeris data.

Almanac, ionosphere, UTC correction and SV health data are transmitted by all SVs simultaneously. Therefore these parameters can be downloaded when a single SV is tracked with a high enough C/N0.

Allowing more ephemerides to be downloaded before going into *POT* or (*Inactive*) *awaiting next fix* state can help improve the quality of the fixes and reduce the number of wake ups needed to download ephemerides at the cost of extra time in *Acquisition* state (only when an inadequate number of ephemerides are downloaded from tracked satellites).

3.8.2.2 Configuration

Power save mode is enabled and disabled with *CFG-PM-OPERATEMODE* and configured with items in the *CFG-PM* group.



When enabling power save mode, the receiver will be unable to download or process any SBAS data. Therefore, there is no benefit in enabling SBAS and it is recommended to disable it. SBAS support can be disabled in the *CFG-SIGNAL* group.

A number of parameters can be used to customize PSM to your specific needs. These parameters, which can be found in the *CFG-PM* group, are listed in the following table:

Config key	Description
OPERATEMODE	Receiver mode of operation
POSUPDATEPERIOD	Time between two position fix attempts in on/off power save mode
ACQPERIOD	Time between two acquisition attempts if the receiver is unable to get a position fix
MINACQTIME	Minimum time the receiver spends in <i>Acquisition</i> state
ONTIME	Time the receiver remains in <i>Tracking</i> state and produces position fixes
WAITTIMEFIX	Wait for time fix before entering <i>Tracking</i> state
DONOTENTEROFF	Receiver does not enter (<i>Inactive</i>) <i>awaiting next search</i> state if it cannot get a position fix but keeps indefinitely attempting a position fix instead
UPDATEEPH	Enables periodic ephemeris update
EXTINTSEL	Selects EXTINT pin used with pin control feature
EXTINTWAKE	Enables force-ON pin control feature
EXTINTBACKUP	Enables force-OFF pin control feature
EXTINTINACTIVE	Enables sleep on inactivity feature
EXTINTINACTIVITY	Specifies allowed inactivity period
GRIDOFFSET	Time offset of update grid with respect to start of week
MAXACQTIME	Maximum time in <i>Acquisition</i> state

Table 18: Power save mode configuration options in the CFG-PM group

3.8.2.2.1 Mode of operation (OPERATEMODE)

The mode of operation to use mainly depends on the update period: For short update periods (in the range of a few seconds), cyclic tracking should be configured. For long update periods (in the range of minutes or longer), only use on/off operation.

See section [On/off operation - long update period](#) and [Cyclic tracking operation - short update period](#) for more information on the two modes of operation.

3.8.2.2.2 Reference time standard

Where multiple GNSS can operate simultaneously, UTC time standard is used for the operation of PSM.

3.8.2.2.3 Update period (POSUPDATEPERIOD) and search period (ACQPERIOD)

The update period specifies the time between successive position fixes. If no position fix can be obtained within the acquisition timeout, the receiver will retry after the time specified by the search period. Update and search periods are fixed with respect to an absolute time grid based on reference time standard (i.e., GPS Time or UTC, see [Reference Time Standard](#)). They do not refer to the time of the last valid position fix or last position fix attempt.



The update period (POSUPDATEPERIOD) setting is ignored if the receiver is set into cyclic tracking mode. It only has an impact if the receiver is set to on/off mode.



New settings are ignored if the update period or the search period exceeds the maximum number of milliseconds in a week. In that case the previously stored values remain effective.

3.8.2.2.4 Minimum acquisition time (MINACQTIME)

The receiver tries to obtain a position fix for at least the time given in *MINACQTIME*. If the receiver determines that it needs more time for the given starting conditions then it will automatically prolong this time. If *MINACQTIME* is set to zero then the minimum acquisition time is exclusively determined by the receiver. Once the *MINACQTIME* has expired, the receiver will terminate the acquisition state if either a fix is achieved or if the receiver estimates that any signals received are insufficient (too weak or too few) for a fix to be possible.

3.8.2.2.5 On time (ONTIME)

The *ONTIME* parameter specifies how long the receiver stays in *Tracking* state before switching to the *POT* state (in PSMCT) or (*Inactive*) *awaiting next fix* state (in PSMOO).

3.8.2.2.6 Wait for time fix (WAITTIMEFIX)

A time fix is a fix type in which the receiver will ensure that the time is accurate and confirmed to within the limits set in CFG-NAVSPG. Enabling the *WAITTIMEFIX* option will force the receiver to stay in *Acquisition* state until the time is known to be within the configured limits, then it will transition to *Tracking* state. Take into account that enabling *waitTimeFix* will delay the transition from *Acquisition* state to *Tracking* state by at least two extra seconds (see [Acquisition Timeout](#)). It is necessary to enable *WAITTIMEFIX* in timing products.

The quality of the position fixes can also be configured by setting the limits in the CFG-NAVSPG group. Setting harder limits in CFG-NAVSPG will typically prolong the time in *Acquisition* state. Thus, ensuring sufficient time is given to the receiver at start-up (when externally controlled) is necessary (see [Acquisition Timeout Logic](#)). When internally controlled, the receiver can make good judgment on the time needed in *Acquisition* state and no further adjustments will be needed.

3.8.2.2.7 Maximum startup state duration (MAXACQTIME)

The *MAXACQTIME* is the maximum time that the receiver will spend in *Startup* state (i.e., *Acquisition* state). If the receiver is unable to acquire a valid position fix within this maximum time, it will transition to (*Inactive*) *awaiting next search* state (if *DONOTENTEROFF* is disabled). Subsequently, the receiver will attempt to acquire another position fix according to the search period (see [Update period \(POSUPDATEPERIOD\)](#) and [search period \(ACQPERIOD\)](#)). If *MAXACQTIME* is set to zero, the receiver will autonomously determine the maximum time to spend in *Acquisition* state. Note that shorter settings (below about 45 s) will degrade an unaided receiver's ability to collect new Ephemeris data at low signal levels (see section [Satellite data download](#)).

3.8.2.2.8 Do not enter '(Inactive) awaiting next search' state when no fix (DONOTENTEROFF)

If this option is enabled, the receiver acts differently in case it cannot get a fix: instead of entering (*Inactive*) *awaiting next search* state, it keeps attempting to acquire a position fix. In other words, the receiver will never be in (*Inactive*) *awaiting next search* state and therefore *searchPeriod* and *MINACQTIME* will be ignored.

3.8.2.2.9 Update ephemeris (UPDATEEPH)

To maintain the ability of a fast start-up, the receiver needs to update its ephemeris data on a regular basis. This can be ensured by activating the update Ephemeris option (*UPDATEEPH*). The ephemeris data is updated approximately every 30 minutes. See section [Satellite data download](#) for more information.

3.8.2.2.10 EXTINT pin control

The operation of PSM can be externally controlled using either *EXTINT0* or *EXTINT1* pin. This external control allows the user to decide when to wake up the receiver to obtain a fix and when to force the receiver into sleep/backup mode to save power. Operating the receiver externally through the *EXTINT* pins will override internal functions that coincide with that specific operation.

The choice of which pin to use can be configured through the *EXTINTSEL* feature in CFG-PM. Only one pin can be selected at a time but it is sufficient to perform all the required tasks.

If the Force-ON (*EXTINTWAKE*) feature in CFG-PM is enabled, the receiver will not enter *Inactive* states for as long as the configured *EXTINT* pin (*EXTINT0* or *EXTINT1*) is at 'high' level. The receiver will therefore always be in *Acquisition/Tracking* state in PSMOO or in *Acquisition/Tracking/POT* state in PSMCT. When the pin level changes to 'low' the receiver will continue with its configured behavior.

If the Force-OFF (*EXTINTBACKUP*) feature in CFG-PM is enabled, the receiver will enter Inactive states for as long as the configured EXTINT pin is set to 'low' until the next wake-up event. Any wake-up event can wake up the receiver even while the EXTINT pin is set to 'low' (see [Wake up](#)). However, if the pin stays at 'low' state, the receiver will only wake up for the time needed to read the configuration pin settings, then it will enter the Inactive state again.

If both Force-ON and Force-OFF features are enabled at the same time, the receiver PSM operation will be completely in user's control. Setting 'high' on the configured EXTINT pin will wake up the receiver to get a position fix and setting 'low' will put the receiver into sleep/backup mode.

3.8.2.2.11 Grid offset (GRIDOFFSET)

Once the receiver has a valid time, the update grid is aligned to the start of the week of the [reference time standard](#) (midnight between Saturday and Sunday). Before having a valid time, the update grid is unaligned. A grid offset shifts the update grid with respect to the start of the week of the [reference time standard](#). An example of usage can be found in section [Use grid offset](#).

 The grid offset is not used in cyclic tracking operation.

3.8.2.3 Features

3.8.2.3.1 Communication

When PSM is enabled, communication with the receiver (e.g. UBX message to disable PSM) requires particular attention. This is because the receiver may be in *Inactive* state and therefore unable to receive any message through its interfaces. To ensure that the configuration messages are processed by the receiver, even while in *Inactive* state, the following steps need to be taken:

- Send a dummy sequence of 0xFF (one byte is sufficient) to the receiver's UART interface. This will wake up the receiver if it is in *Inactive* state. If the receiver is not in *Inactive* state, the sequence will be ignored.
- Send the configuration message about half a second after the dummy sequence. If the interval between the dummy sequence and the configuration message is too short, the receiver may not yet be ready. If the interval is too long, the receiver may return to *Inactive* state before the configuration message was received. It is therefore important to check for a UBX-ACK-ACK reply from the receiver to confirm that the configuration message was received. The configuration should be saved in a non-volatile layer (such as BBR or flash memory layer).

Similarly, when configuring the receiver for PSMOO (and PSMCT when *DONOTENTEROFF* is disabled), ensure that the configurations are set in non-volatile layer. If they are not in a non-volatile layer, the receiver will enter backup mode and when it wakes up again, it has lost the configuration and has even forgotten it was in power save mode. This can be avoided if the key values of the configuration items are saved into the BBR. If they are only saved into RAM, they will be lost after the first backup entry (see [Receiver Configuration](#) for details). When operating PSM from u-center and setting the receiver to power save mode with CFG-PM-OPERATEMODE, check which layer the setting is saved to.

3.8.2.3.2 Wake up

The receiver can be woken up by generating an edge on one of the following pins:

- rising or falling edge on one of the EXTINT pins
- rising or falling edge on the RXD pin
- rising edge on NRESET pin

All wake-up signals are interpreted as a position request, where the receiver wakes up and tries to obtain a position fix. Wake-up signals have no effect if the receiver is already in *Acquisition*, *Tracking* or *POT* state.

3.8.2.3.3 Behavior while USB host connected

As long as the receiver is connected to a USB host, it will not enter the lowest possible power state. This is because it must retain a small level of CPU activity to avoid breaching requirements of the USB specification. The drawback, however, is that power consumption is higher.



Wake up by pin/UART is possible even if the receiver is connected to a USB host. In this case the state of the pin must be changed for a duration longer than one millisecond.

3.8.2.3.4 Cooperation with the AssistNow Autonomous feature

If both PSM and [AssistNow Autonomous](#) features are enabled, the receiver will not enter (*Inactive*) *awaiting next fix* state as long as *AssistNow Autonomous* carries out calculations. This prevents losing data from unfinished calculations and, in the end, reduces the total extra power needed for *AssistNow Autonomous*. The delay before entering (*Inactive*) *awaiting next fix* state, if any, will be in the range of several seconds, rarely more than 20 seconds.

Only entering (*Inactive*) *awaiting next fix* state is affected by *AssistNow Autonomous*. This means that: in cyclic tracking operation, *AssistNow Autonomous* will not interfere with the PSM (apart from the increased power consumption).



Enabling the *AssistNow Autonomous* feature will lead to increased power consumption while prediction is calculated. The main goal of PSM is to reduce the overall power consumption. Therefore for each application special care must be taken to judge whether *AssistNow Autonomous* is beneficial to the overall power consumption or not.

3.8.2.4 Examples

3.8.2.4.1 Use grid offset

Scenario: Get a position fix once a day at a fixed time. If the position fix cannot be obtained try again every two hours.

Solution: First set the update period (*POSUPDATEPERIOD*) to $24 \cdot 3600$ s and the search period (*ACQPERIOD*) to $2 \cdot 3600$ s. Now a position fix is obtained every 24 hours and if the position fix fails retrials are scheduled in two-hour intervals. As the update grid is aligned to midnight Saturday/Sunday [reference time standard](#), the position fixes happen at midnight [reference time standard](#). By setting the grid offset (*GRIDOFFSET*) to $12 \cdot 3600$ s the position fixes are shifted to once a day at noon [reference time standard](#). If the position fix at noon fails, retrials take place every two hours, the first at 14:00 [reference time standard](#). Upon successfully acquiring a position fix the next fix attempt is scheduled for noon the following day.

3.8.2.4.2 User-controlled position fix

Scenario: Get a position fix on request.

Solution: Set *POSUPDATEPERIOD* and *ACQPERIOD* to zero. Set *EXTINTSEL* to the desired EXTINT pin to be used. Enable the *EXTINTWAKE* and *EXTINTBACKUP* features.

3.8.2.4.3 Use update periods of 30 minutes

Scenario: Get a position fix once every 30 minutes and acquire a fix needed for timing products.

Solution: Set mode of operation to PSMOO. Set *POSUPDATEPERIOD* to 1800 seconds. Set the search period to 120 seconds. Enable *WAITTIMEFIX* feature.

3.8.3 Peak current settings

The peak current during acquisition can be reduced by activating the corresponding option in CFG-PM-LIMITPEAKCURR. A peak current reduction will result in longer start-up times of the receiver.

 This setting is independent of the activated mode (continuous or power save mode).

3.8.4 Power on/off command

With message UBX-RXM-PMREQ the receiver can be forced to enter *Inactive* state (in continuous and power save mode). It will stay in *Inactive* state for the time specified in the message or until it is woken up by an EXTINT or activity on the RXD, SPI CS, or NRESET pin.

 Sending the message UBX-RXM-PMREQ while the receiver is in power save mode will overrule PSM and force the receiver to enter *Inactive* state. It will stay in *Inactive* state until woken up. After wake-up the receiver continues working in power save mode as configured.

3.8.5 EXTINT pin control when power save mode is not active

The receiver can be forced OFF also when the power save mode is not active. This works the same way as [EXTINT pin control in power save mode](#). Just as in power save mode, this feature has to be enabled and configured in CFG-PM.

3.8.6 Measurement and navigation rate with power save mode

In Continuous Mode, measurement and navigation rate is configured using CFG-RATE. In power save mode however, measurement and navigation rate can differ from the configured rates as follows:

- **Cyclic operation:** When in state *Power optimized tracking*, the measurement and navigation rate is given by the value given by the item *MEAS* in group CFG-RATE. PSM can only be enabled when *MEAS* is set to 500 ms or $x \cdot 1000$ ms with $x = 1 \dots 10$. The receiver can however switch to *Tracking* state (e.g. to download data). Note: When the receiver is no longer able to produce position fixes, it can switch from cyclic operation to on/off operation (if this is not disabled with the *DONOTENTEROFF* switch in CFG-PM). In that case the remarks below are relevant.
- **On/off operation:** When in state *Acquisition*, the measurement and navigation rate is **fixed to 2 Hz**. All NMEA (and UBX) messages that are output upon a navigation fix are also output with a rate of 2 Hz. This must be considered when choosing the baud rate of a receiver that uses power save mode! Note that a receiver might stay in *Acquisition* state for quite some time (can be tens of seconds under weak signal conditions). When the receiver eventually switches to *Tracking* state, the measurement and navigation rate will be as configured with CFG-RATE. However, the measurement and navigation rate will be as configured with CFG-RATE in all active states.

3.8.7 Backup modes

When the receiver is set into backup mode, it consumes only a fraction of the normal power usage and if it is powered up again will be able to make a position fix within a very short time. This is the "hot start". The hot start fix time is given in the NEO-M9N Datasheet [1].

The NEO-M9N supports two kinds of backup modes. These are:

- Hardware backup mode
- Software backup mode

The "hardware backup" mode is for designs where a battery supply is always present. For designs where the battery supply is not available, software backup and the safe-on-shutdown feature can be used. See more information about the safe-on-shutdown feature (SOS-feature) in the NEO-M9N Interface description [2].

The software backup mode is very similar to the "power save mode on/off operation" and can be enabled with the command described in [Power on/off command](#).

3.9 Clocks and time

This section introduces and explains the concepts of receiver clocks and time bases.

3.9.1 Receiver local time

The receiver is dependent on a local oscillator for both the operation of its radio parts and also for timing within its signal processing. No matter what nominal frequency the local oscillator has, u-blox receivers subdivide the oscillator signal to provide a 1 kHz reference clock signal, which is used to drive many of the receiver's processes. In particular, the measurement of satellite signals is arranged to be synchronized with the "ticking" of this 1 kHz clock signal.

When the receiver first starts, it has no information about how these clock ticks relate to other time systems; it can only count time in 1 millisecond steps. However, as the receiver derives information from the satellites it is tracking or from aiding messages, it estimates the time that each 1 kHz clock tick takes in the time-base of the relevant GNSS system. In previous generations of u-blox receivers this was always the GPS time-base, but for the current generation it could be GPS, GLONASS, Galileo, or BeiDou. This estimate of GNSS time based on the local 1 kHz clock is called receiver local time.

As receiver local time is a mapping of the local 1 kHz reference onto a GNSS time-base, it may experience occasional discontinuities, especially when the receiver first starts up and the information it has about the time-base is changing. Indeed, after a cold start, the receiver local time will initially indicate the length of time that the receiver has been running. However, when the receiver obtains some credible timing information from a satellite or an aiding message, it will jump to an estimate of GNSS time.

3.9.2 Navigation epochs

Each navigation solution is triggered by the tick of the 1 kHz clock nearest to the desired navigation solution time. This tick is referred to as a navigation epoch. If the navigation solution attempt is successful, one of the results is an accurate measurement of time in the time-base of the chosen GNSS system, called GNSS system time. The difference between the calculated GNSS system time and receiver local time is called the clock bias (and the clock drift is the rate at which this bias is changing).

In practice the receiver's local oscillator will not be as stable as the atomic clocks to which GNSS systems are referenced and consequently clock bias will tend to accumulate. However, when selecting the next navigation epoch, the receiver will always try to use the 1 kHz clock tick which it estimates to be closest to the desired fix period as measured in GNSS system time. Consequently the number of 1 kHz clock ticks between fixes will occasionally vary. This means that when producing one fix per second, there will normally be 1000 clock ticks between fixes, but sometimes, to correct drift away from GNSS system time, there will be 999 or 1001.

The GNSS system time calculated in the navigation solution is always converted to a time in both the GPS and UTC time-bases for output.

Clearly when the receiver has chosen to use the GPS time-base for its GNSS system time, conversion to GPS time requires no work at all, but conversion to UTC requires knowledge of the number of leap seconds since GPS time started (and other minor correction terms). The relevant GPS-to-UTC conversion parameters are transmitted periodically (every 12.5 minutes) by GPS satellites, but can also be supplied to the receiver via the UBX-MGA-GPS-UTC aiding message. By contrast when the receiver has chosen to use the GLONASS time-base as its GNSS system time, conversion to GPS time is more difficult as it requires knowledge of the difference between the two time-bases, but as GLONASS time is closely linked to UTC, conversion to UTC is easier.

Where insufficient information is available for the receiver to perform any of these time-base conversions precisely, pre-defined default offsets are used. Consequently plausible times are nearly always generated, but they may be wrong by a few seconds (especially shortly after receiver start). Depending on the configuration of the receiver, such "invalid" times may well be output, but with flags indicating their state (e.g. the "valid" flags in UBX-NAV-PVT).



u-blox receivers employ multiple GNSS system times and/or receiver local times (in order to support multiple GNSS systems concurrently), so users should not rely on UBX messages that report GNSS system time or receiver local time being supported in future. It is therefore recommended to give preference to those messages that report UTC time.

3.9.3 iTOW timestamps

All the main UBX-NAV messages (and some other messages) contain an iTOW field which indicates the GPS time at which the navigation epoch occurred. Messages with the same iTOW value can be assumed to have come from the same navigation solution.

Note that iTOW values may not be valid (i.e. they may have been generated with insufficient conversion data) and therefore it is not recommended to use the iTOW field for any other purpose.



The original designers of GPS chose to express time/date as an integer week number (starting with the first full week in January 1980) and a time of week (often abbreviated to TOW) expressed in seconds. Manipulating time/date in this form is far easier for digital systems than the more conventional year/month/day, hour/minute/second representation. Consequently, most GNSS receivers use this representation internally, only converting to a more conventional form at external interfaces. The iTOW field is the most obvious externally visible consequence of this internal representation.

If reliable absolute time information is required, users are recommended to use the UBX-NAV-PVT navigation solution message which also contains additional fields that indicate the validity (and accuracy in UBX-NAV-PVT) of the calculated times (see also section [GNSS times](#) for further messages containing time information).

3.9.4 GNSS times

Each GNSS has its own time reference for which detailed and reliable information is provided in the messages listed in the table below.

Time reference	Message
GPS time	UBX-NAV-TIMEGPS
BeiDou time	UBX-NAV-TIMEBDS
GLONASS time	UBX-NAV-TIMEGLO
Galileo time	UBX-NAV-TIMEGAL
UTC time	UBX-NAV-TIMEUTC



Table 19: GNSS times

3.9.5 Time validity

Information about the validity of the time solution is given in the following form:

- **Time validity:** Information about time validity is provided in the `valid` flags (e.g. `validDate` and `validTime` flags in the UBX-NAV-PVT message). If these flags are set, the time is known and considered as valid for being used. These flags are shown in table GNSS times in section GNSS times above as well as in the UBX-NAV-PVT message.
- **Time validity confirmation:** Information about confirmed validity is provided in the `confirmedDate` and `confirmedTime` flags in the UBX-NAV-PVT message. If these flags are

set, the time validity can be confirmed by using an additional independent source, meaning that the probability of the time to be correct is very high. Note that information about time validity confirmation is only available if the `confirmedAvai` bit in the UBX-NAV-PVT message is set.

-  `validDate` means that the receiver has knowledge of the current date. However, it must be noted that this date might be wrong for various reasons. Only when the `confirmedDate` flag is set, the probability of the incorrect date information drops significantly.
-  `validTime` means that the receiver has knowledge of the current time. However, it must be noted that this time might be wrong for various reasons. Only when the `confirmedTime` flag is set, the probability of incorrect time information drops significantly.
-  `fullyResolved` means that the UTC time is known without full seconds ambiguity. When deriving UTC time from GNSS time the number of leap seconds must be known, with the exception of GLONASS. It might take several minutes to obtain such information from the GNSS payload. When the one second ambiguity has not been resolved, the time accuracy is usually in the range of ~20s.

3.9.6 UTC representation

UTC time is used in many NMEA and UBX messages. In NMEA messages it is always reported rounded to the nearest hundredth of a second. Consequently, it is normally reported with two decimal places (e.g. 124923.52). What is more, although compatibility mode (selected using CFG-NMEA-COMPAT) requires three decimal places, rounding to the nearest hundredth of a second remains, so the extra digit is always 0.

UTC time is also reported within some UBX messages, such as UBX-NAV-TIMEUTC and UBX-NAV-PVT. In these messages date and time are separated into seven distinct integer fields. Six of these (year, month, day, hour, min and sec) have fairly obvious meanings and are all guaranteed to match the corresponding values in NMEA messages generated by the same navigation epoch. This facilitates simple synchronization between associated UBX and NMEA messages.

The seventh field is called nano and it contains the number of nanoseconds by which the rest of the time and date fields need to be corrected to get the precise time. So, for example, the UTC time 12:49:23.521 would be reported as: hour: 12, min: 49, sec: 23, nano: 521000000.

It is however important to note that the first six fields are the result of rounding to the nearest hundredth of a second. Consequently the nano value can range from -5000000 (i.e. -5 ms) to +994999999 (i.e. nearly 995 ms).

When the nano field is negative, the number of seconds (and maybe minutes, hours, days, months or even years) will have been rounded up. Therefore, some or all of them must be adjusted in order to get the correct time and date. Thus in an extreme example, the UTC time 23:59:59.9993 on 31st December 2011 would be reported as: year: 2012, month: 1, day: 1, hour: 0, min: 0, sec: 0, nano: -700000.

Of course, if a resolution of one hundredth of a second is adequate, negative nano values can simply be rounded up to 0 and effectively ignored.

Which master clock the UTC time is referenced to is output in the message UBX-NAV-TIMEUTC.

The preferred variant of UTC time can be specified using CFG-NAVSPG-UTCSTANDARD configuration item.

3.9.7 Leap seconds

Occasionally it is decided (by one of the international time keeping bodies) that, due to the slightly uneven spin rate of the Earth, UTC has moved sufficiently out of alignment with mean solar time (i.e. the Sun no longer appears directly overhead at 0 longitude at midday). A "leap second" is therefore announced to bring UTC back into close alignment. This normally involves adding an extra second to the last minute of the year, but it can also happen on 30th June. When this happens UTC clocks are expected to go from 23:59:59 to 23:59:60 and only then on to 00:00:00.

It is also theoretically possible to have a negative leap second, in which case there will only be 59 seconds in a minute and 23:59:58 will be followed by 00:00:00.

u-blox receivers are designed to handle leap seconds in their UTC output and consequently users processing UTC times from either NMEA and UBX messages should be prepared to handle minutes that are either 59 or 61 seconds long.

Leap second information can be polled from the u-blox receiver with the message UBX-NAV-TIMELS.

3.9.8 Real time clock

u-blox receivers contain circuitry to support a real time clock, which (if correctly fitted and powered) keeps time while the receiver is otherwise powered off. When the receiver powers up, it attempts to use the real time clock to initialize receiver local time and in most cases this leads to appreciably faster first fixes.

3.9.9 Date

All GNSS frequently transmit information about the current time within their data message. In most cases, this is a time of week (often abbreviated to TOW), which indicates the elapsed number of seconds since the start of the week (midnight Saturday/Sunday). In order to map this to a full date, it is necessary to know the week and so the GNSS also transmit a week number, typically every 30 seconds. Unfortunately the GPS L1C/A data message was designed in a way that only allows the bottom 10 bits of the week number to be transmitted. This is not sufficient to yield a completely unambiguous date as every 1024 weeks (a bit less than 20 years), the transmitted week number value "rolls over" back to zero. Consequently, GPS L1 receivers cannot tell the difference between, for example, 1980, 1999 or 2019 etc.

Fortunately, although BeiDou and Galileo have similar representations of time, they transmit sufficient bits for the week number to be unambiguous for the foreseeable future (the first ambiguity will be in 2078 for Galileo and not until 2163 for BeiDou). GLONASS has a different structure, based on a time of day, but again transmits sufficient information to avoid any ambiguity during the expected lifetime of the system (the first ambiguous date will be in 2124). Therefore, u-blox 9 receivers using Protocol Version 24 and above regard the date information transmitted by GLONASS, BeiDou and Galileo to be unambiguous and, where necessary, use this to resolve any ambiguity in the GPS date.



Customers attaching u-blox receivers to simulators should be aware that GPS time is referenced to 6th January 1980, GLONASS to 1st January 1996, Galileo to 22nd August 1999 and BeiDou to 1st January 2006; the receiver cannot be expected to work reliably with signals that appear to come from before these dates.

3.9.9.1 GPS-only date resolution

In circumstances where only GPS L1C/A signals are available and for receivers with earlier firmware versions, the receiver establishes the date by assuming that all week numbers must be at least as large as a reference rollover week number. This reference rollover week number is hard-coded at compile time and is normally set a few weeks before the software is completed, but it can be overridden by CFG-NAVSPG-WKNROLLOVER configuration item to any value the user wishes.

The following example illustrates how this works: Assume that the reference rollover week number set in the firmware at compile time is 1524 (which corresponds to a week in calendar year 2009, but would be transmitted by the satellites as 500). In this case, if the receiver sees transmissions containing week numbers in the range of 500 ... 1023, these will be interpreted as week numbers 1524 ... 2047 (calendar year 2009 ... 2019), whereas transmissions with week numbers from 0 to 499 are interpreted as week numbers 2048 ... 2547 (calendar year 2019 ... 2028).



It is important to set the reference rollover week number appropriately when supplying u-blox receivers with simulated signals, especially when the scenarios are in the past.

3.10 Timing functionality

In addition to positioning and navigation applications, GNSS signals are widely used as low-cost precision time or frequency references used by remote or distributed wireless communication, industrial, financial, and power distribution equipment. By capitalizing on atomic clocks which are on-board positioning satellites, GNSS signals which contain embedded timing information can be used to synchronize equipment, as well as to provide UTC time. For wireless communication standards that utilize Time Division Multiplex (TDM) and applications such as femtocell base stations, a precision time reference is mandatory.

3.10.1 Time pulse

3.10.1.1 Introduction

u-blox receivers include a time pulse function providing clock pulses with configurable duration and frequency. The time pulse function can be configured using the CFG-TP-* configuration group. The UBX-TIM-TP message provides time information for the next pulse and the time source.

Pulse Mode: Rising



Pulse Mode: Falling

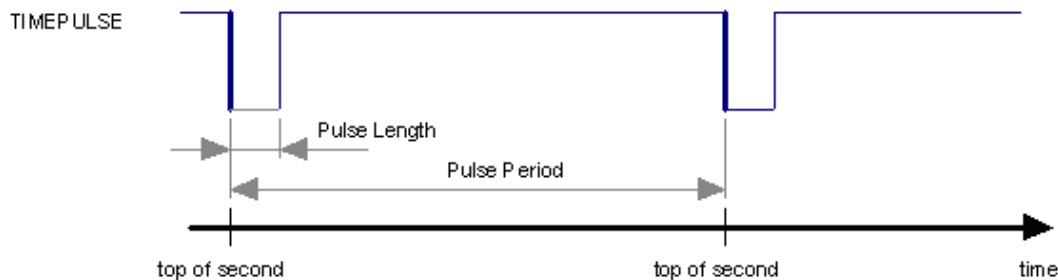

Figure 20: Time pulse

3.10.1.2 Recommendations

- The time pulse can be aligned to a wide variety of GNSS times or to variants of UTC derived from them (see the chapter on [time bases](#)). However, it is strongly recommended that the choice of time base is aligned with the available GNSS signals (so to produce GPS time or UTC(USNO), ensure GPS signals are available, and for GLONASS time or UTC(SU) ensure the presence GLONASS signals). This will involve coordinating the setting of CFG-SIGNAL-* configuration group with the choice of time pulse time base.
- When using time pulse for precision timing applications it is recommended to calibrate the antenna cable delay against a reference timing source.
- In order to get the best timing accuracy with the antenna, a fixed and *accurate* position is needed.
- If relative time accuracy between multiple receivers is required, do not mix receivers of different product families. If this is required, the receivers must be calibrated accordingly, by setting cable delay and user delay.
- The recommended configuration when using the UBX-TIM-TP message is to set both the measurement rate (CFG-RATE-MEAS) and the time pulse frequency (CFG-TP-*) to 1 Hz.



Since the rate of UBX-TIM-TP is bound to 1 Hz, more than one UBX-TIM-TP message can appear between two pulses if the time pulse frequency is set larger than 1 Hz. In this case all UBX-TIM-TP messages in between a time pulse T1 and T2 belong to T2 and the last UBX-TIM-TP before T2 reports the most accurate quantization error. In general, if the time pulse rate is not configured to 1 Hz, there will not be a single UBX-TIM-TP message for each time pulse.



Since the rate of UBX-TIM-TP is bound to 1 Hz, more than one UBX-TIM-TP message can appear between two pulses if the time pulse frequency is set larger than 1 Hz. In general, if the time pulse rate is not configured to 1 Hz, there will not be a single UBX-TIM-TP message for each time pulse.

The sequential order of the signal present at the TIMEPULSE pin and the respective output message for the simple case of 1 pulse per second (1PPS) is shown in the following figure.

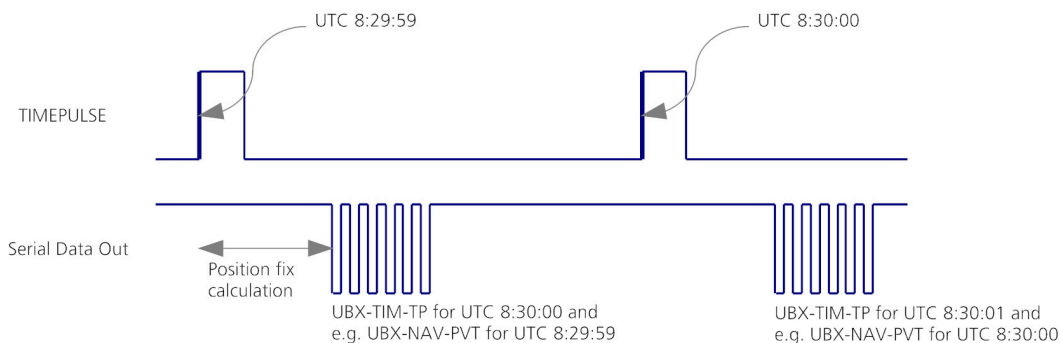

Figure 21: Time pulse and TIM-TP

3.10.1.3 GNSS time bases

GNSS receivers must handle a variety of different time bases as each GNSS has its own reference system time. What is more, although each GNSS provides a model for converting their system time into UTC, they all support a slightly different variant of UTC. So, for example, GPS supports a variant of UTC as defined by the US National Observatory, while BeiDou uses UTC from the National Time Service Center, China (NTSC). While the different UTC variants are normally closely aligned, they can differ by as much as a few hundreds of nanoseconds.

Although u-blox receivers can combine a variety of different GNSS times internally, the user must choose a single type of GNSS time and, separately, a single type of UTC for input (on EXTINTs) and output (via the time pulse) and the parameters reported in corresponding messages.

The CFG-TP-* configuration group allows the user to choose between any of the supported GNSS (GPS, GLONASS, BeiDou, etc) times and UTC. Also, the CFG-NAVSPG-* configuration group allows the user to select which variant of UTC the receiver should use. This includes an "automatic" option which causes the receiver to select an appropriate UTC version itself, based on the GNSS configuration, using, in order of preference, USNO if GPS is enabled, SU if GLONASS is enabled, NTSC if BeiDou is enabled and, finally, European if Galileo is enabled.

The receiver will assume that the input time pulse uses the same GNSS time base as specified for the output using CFG-TP-*. So if the user selects GLONASS time for time pulse output, any time pulse input must also be aligned to GLONASS time (or to the separately chosen variant of UTC). Where UTC is selected for time pulse output, any GNSS time pulse input will be assumed to be aligned to GPS time.

 u-blox receivers allow users to independently choose GNSS signals used in the receiver (using CFG-SIGNAL-*) and the input/output time base (using CFG-TP-*). For example it is possible to instruct the receiver to use GPS and GLONASS satellite signals to generate BeiDou time. This practice will compromise time-pulse accuracy if the receiver cannot measure the timing difference between the constellations directly and is therefore not recommended.

 The information that allows GNSS times to be converted to the associated UTC times is only transmitted by the GNSS at relatively infrequent periods. For example GPS transmits UTC(USNO) information only once every 12.5 minutes. Therefore, if a time pulse is configured to use a variant of UTC time, after a cold start, substantial delays before the receiver has sufficient information to start outputting the time pulse can be expected.

3.10.1.4 Time pulse configuration

u-blox NEO-M9N receivers provide a time pulse (TIMEPULSE) signal with a configurable pulse period, pulse length and polarity (rising or falling edge).

It is possible to define different signal behavior (i.e. output frequency and pulse length) depending on whether or not the receiver is locked to a reliable time source. Time pulse signal can be configured using the configuration group CFG-TP-*.

The NEO-M9N module provides only one time pulse pin. Configuration for TP1 applies to this pin.

3.10.1.5 Configuring time pulse with CFG-TP-*

The configuration group CFG-TP-* can be used to change the time pulse settings, and includes the following parameters defining the pulse:

- **timepulse enable** - Time pulse is active if this item is set.
- **frequency/period type** - Determines whether the time pulse is interpreted as frequency or period.
- **length/ratio type** - Determines whether the time pulse length is interpreted as length[us] or pulse ratio[%].
- **antenna cable delay** - Signal delay due to the cable between antenna and receiver.
- **pulse frequency/period** - Frequency or period time of the pulse when locked mode is not configured or active.
- **pulse frequency/period lock** - Frequency or period time of the pulse, as soon as receiver has calculated a valid time from a received signal. Only used if the corresponding item is set to use another setting in locked mode.

- **pulse length/ratio** - Length or duty cycle of the generated pulse, either specifies a time or ratio for the pulse to be on/off.
- **pulse length/ratio lock** - Length or duty cycle of the generated pulse, as soon as receiver has calculated a valid time from a received signal. Only used if the corresponding item is set to use another setting in locked mode.
- **user delay** - The cable delay from the receiver to the user device plus signal delay of any user application.
- **lock to GNSS freq** - Use frequency gained from GNSS signal information rather than local oscillator's frequency if item is set.
- **locked other setting** - If this item is set, as soon as the receiver can calculate a valid time, the alternative setting is used. This mode can be used for example to disable time pulse if time is not locked, or indicate lock with different duty cycles.
- **align to TOW** - If this item is set, pulses are aligned to the top of a second.
- **polarity** - If set, the first edge of the pulse is a rising edge (pulse polarity: rising).
- **grid UTC/GNSS** - Selection between UTC (0), GPS (1), GLONASS (2) and BeiDou (3) timegrid. Also affects the time output by UBX-TIM-TP message.



The maximum pulse length cannot exceed the pulse period.



Time pulse settings shall be chosen in such a way, that neither the high nor the low period of the output is less than 50 ns (except when disabling it completely), otherwise pulses can be lost.

3.10.1.5.1 Example

The example below shows the 1PPS TIMEPULSE signal generated on the time pulse output according to the specific parameters of the CFG-TP-* configuration group:

- **CFG-TP-TP1_ENA** = 1
- **CFG-TP-PERIOD_TP1** = 100 000 μ s
- **CFG-TP-LEN_TP1** = 100 000 μ s
- **CFG-TP-TIMEGRID_TP1** = 1 (GPS)
- **CFG-TP-PULSE_LENGTH_DEF** = 0 (Period)
- **CFG-TP-ALIGN_TO_TOW_TP1** = 1
- **CFG-TP-USE_LOCKED_TP1** = 1
- **CFG-TP-POL_TP1** = 1
- **CFG-TP-PERIOD_LOCK_TP1** = 100 000 μ s
- **CFG-TP-LEN_LOCK_TP1** = 100 000 μ s

The 1 Hz output is maintained whether or not the receiver is locked to GPS time. The alignment to TOW can only be maintained when GPS time is locked.

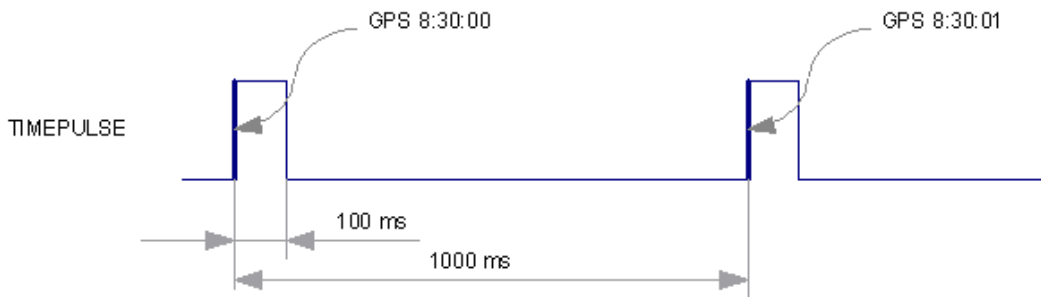

Figure 22: Time pulse signal with the example parameters

3.10.2 Timemark

The receiver can be used to provide an accurate measurement of the time at which a pulse was detected on the external interrupt pin. The reference time can be chosen by setting the time source parameter to UTC, GPS, GLONASS, BeiDou, Galileo or local time in the CFG-TP-* configuration group. The UTC standard can be set in the CFG-NAVSPG-* configuration group. The delay figures defined with CFG-TP-* are also applied to the results output in the UBX-TIM-TM2 message.

A UBX-TIM-TM2 message is output at the next epoch if

- The UBX-TIM-TM2 message is enabled, or
- A rising or falling edge was triggered since last epoch on one of the EXTINT channels.

The UBX-TIM-TM2 messages includes the time of the last timemark, new rising/falling edge indicator, time source, validity, number of marks and a quantization error. The timemark is triggered continuously.



Only the last rising and falling edge detected between two epochs is reported since the output rate of the UBX-TIM-TM2 message corresponds to the measurement rate configured with CFG-RATE-MEAS (see [Figure 23](#) below).

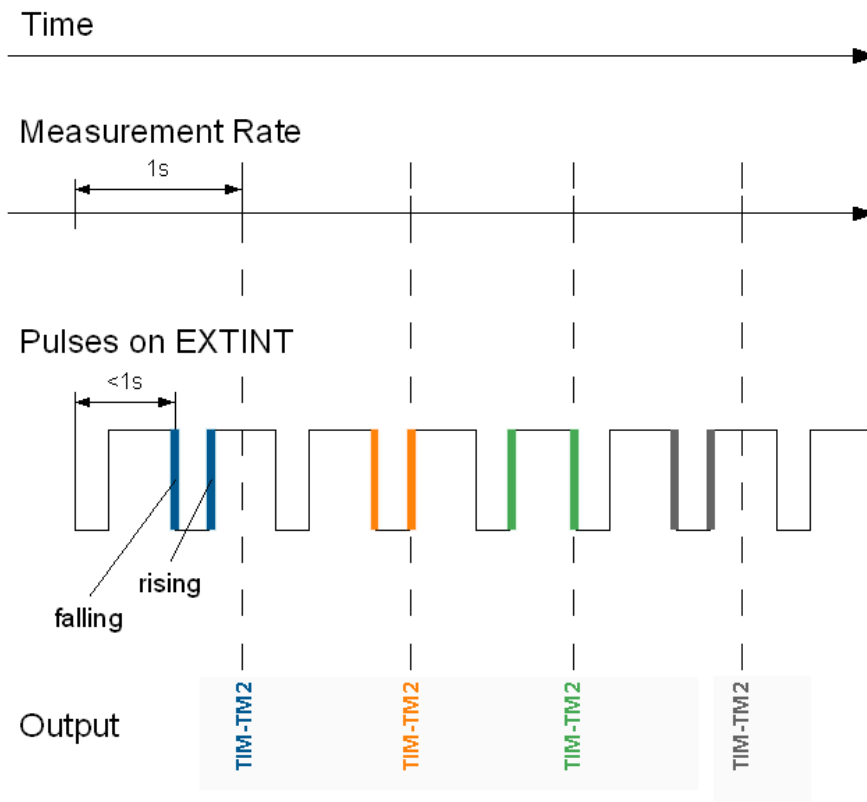

Figure 23: Timemark

3.11 Security

The security concept of NEO-M9N covers the air interface between the receiver and the GNSS satellites and the integrity of the receiver itself.

There are functions to monitor/detect certain security threads and report it to the host system. Other functions try to mitigate the thread and allow the receiver to operate normally.

The table below gives an overview about possible threads and which functionality is available to detect and/or mitigate it.

Threat	u-blox solution
Over air signal integrity	Spoofing detection/mitigation
	Jamming detection/mitigation
GNSS receiver integrity	Secure boot
	Secure firmware update

Threat	u-blox solution
	Receiver configuration lock

Table 20: u-blox security options

3.11.1 Spoofing detection / monitoring

Spoofing is the process whereby someone tries to forge a GNSS signal with the intention of fooling the receiver into calculating a different user position than the true one.

The spoofing detection feature monitors the GNSS signals for suspicious patterns indicating that the receiver is being spoofed. A flag in UBX-NAV-STATUS message (flags2 - spoofDetState) alerts the user to potential spoofing.

The spoofing detection feature monitors suspicious changes in the GNSS signal indicating external manipulation. Therefore the detection is only successful when the signal is genuine first and when the transition to the spoofed signal is being observed directly. When a receiver is started up to a spoofed signal the detection algorithms will be unable to recognize the spoofing. Also, the algorithms rely on availability of signals from multiple GNSS constellations; the detection does not work in single-GNSS mode.

3.11.2 Jamming/interference indicator

The field `jamInd` of the UBX-MON-RF message can be used as an indicator for continuous wave (narrow-band) jammers/interference only. The interpretation of the value depends on the application. It is necessary to run the receiver in an unjammed environment to determine an appropriate value for the unjammed case. If the value rises significantly above this threshold, this indicates that a continuous wave jammer is present.

This indicator is always enabled.

The indicator is reporting any currently detected narrow-band interference over all currently configured signal bands.

3.11.2.1 Jamming/interference monitor (ITFM) / broadband interference monitoring

The field `flags` of the UBX-MON-RF message can be used as an indicator for both broadband and continuous wave (CW) jammers/interference. It is independent of the (CW only) jamming indicator described in [Jamming/interference indicator](#) above.

This monitor reports whether jamming has been detected or suspected by the receiver. The receiver monitors the background noise and looks for significant changes. Normally, with no interference detected, it will report "OK". If the receiver detects that the noise has risen above a preset threshold, the receiver reports "Warning". If in addition, there is no current valid fix, the receiver reports "Critical".

The monitor has four states as shown in the following table:

Value	Reported state	Description
0	Unknown	Jamming/interference monitor not enabled, uninitialized or antenna disconnected
1	OK	no interference detected
2	Warning	position OK but interference is visible (above the thresholds)
3	Critical	no reliable position fix and interference is visible (above the thresholds); interference is probable reason why there is no fix

Table 21: Jamming/interference monitor reported states

The monitor is disabled by default. The monitor is enabled by setting the CFG-ITFM-ENABLE configuration item. In this message it is also possible to specify the thresholds at which broadband and CW jamming are reported. These thresholds should be interpreted as the dB level above "normal". It is also possible to specify whether the receiver expects an active or a passive antenna.



The monitor algorithm relies on comparing the currently measured spectrum with a reference from when a good fix was obtained. Thus the monitor will only function when the receiver has had at least one (good) first fix, and will report "Unknown" before this time.

The monitor is reporting any currently detected interference over all currently configured signal bands.

3.11.3 GNSS receiver integrity

3.11.3.1 Secure boot

The NEO-M9N only runs with firmware images that are signed by u-blox. This makes it impossible, that third party firmware images run on the receiver.

3.11.3.2 Secure firmware update

The firmware image itself is encrypted and signed by u-blox. The NEO-M9N verify the signature at each start.

3.11.3.3 Receiver configuration lock

The receiver lockdown feature ensures, that no configuration can be changed anymore as soon as this feature is enabled. The receiver lockdown is not reversible and there is no back door function or similar available. Once the receiver lockdown is set, the configuration is locked forever.



It is recommended to enable this feature in production. The lockdown is not reversible!

The receiver lockdown feature can be enabled by setting the configuration item CFG-SEC-CFG_LOCK to "true". This can be done in the same way as all other configuration items on various layers. Be aware that if the lockdown feature is set on any non-volatile layer (i.e. flash or BBR) the lockdown is not reversible.



To test the lockdown function, set it in the RAM configuration layer. After the receiver's power cycle, the information in this layer is lost and the lockdown is not set anymore.

3.12 u-blox protocol feature descriptions

3.12.1 Broadcast navigation data

This section describes the data reported via UBX-RXM-SFRBX.

The UBX-RXM-SFRBX reports the broadcast navigation data message collected by the receiver from each tracked signal. When enabled, a separate message is generated every time the receiver decodes a complete subframe of data from a tracked signal. The data bits are reported, as received, including preambles and error checking bits as appropriate. However because there is considerable variation in the data structure of the different GNSS signals, the form of the reported data also varies. Indeed, although this document uses the term "subframe" generically, it is not strictly the correct term for all GNSS (e.g. GLONASS has "strings" and Galileo has "pages").

3.12.1.1 Parsing navigation data subframes

Each UBX-RXM-SFRBX message contains a subframe of data bits appropriate for the relevant GNSS, delivered in a number of 32-bit words, as indicated by the numWords field.

Due to the variation in data structure between different GNSS, the most important step in parsing a UBX-RXMSFRBX message is to identify the form of the data. This should be done by reading the `gnssId` field, which indicates which GNSS the data was decoded from. In almost all cases, this is sufficient to indicate the structure and the following sections are organized by GNSS for that reason. However, in some cases the identity of the GNSS is not sufficient, and this is described, where appropriate, in the following sections.

In most cases, the data does not map perfectly into a number of 32-bit words and, consequently, some of the words reported in UBX-RXM-SFRBX messages contain fields marked as "Pad". These fields should be ignored and no assumption should be made about their contents.

UBX-RXM-SFRBX messages are only generated when complete subframes are detected by the receiver and all appropriate parity checks have passed.

Where the parity checking algorithm requires data to be inverted before it is decoded (e.g. GPS L1C/A), the receiver carries this out before the message output. Therefore, users can process data directly and do not need to worry about repeating any parity processing.

The meaning of the content of each subframe depends on the sending GNSS and is described in the relevant Interface Control Documents (ICD).

3.12.1.2 GPS

NEO-M9N is designed to receive and track the L1C/A signals provided at 1575.42 MHz by the Global Positioning System (GPS).

3.12.1.2.1 GPS L1C/A

For GPS L1C/A signals, there is a fairly straightforward mapping between the reported subframe and the structure of subframe and words described in the GPS ICD. Each subframe comprises ten data words, which are reported in the same order they are received.

Each word is arranged as follows:

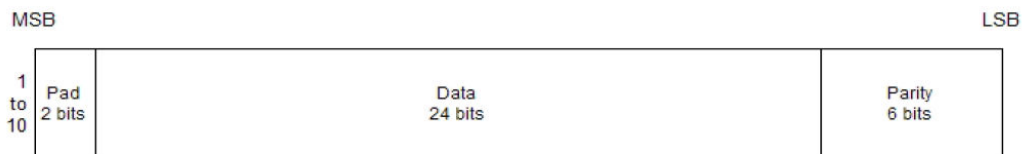

Figure 24: GPS L1C/A subframe word

3.12.1.3 GLONASS

The receivers are designed to receive and track the L1OF signals GLONASS provides at 1602 MHz + $k \cdot 562.5$ kHz, where k is the satellite's frequency channel number ($k = -7, \dots, 5, 6$). The ability to receive and track GLONASS L1OF satellite signals allows design of GLONASS receivers where required by regulations.

The GLONASS words are arranged as follows:

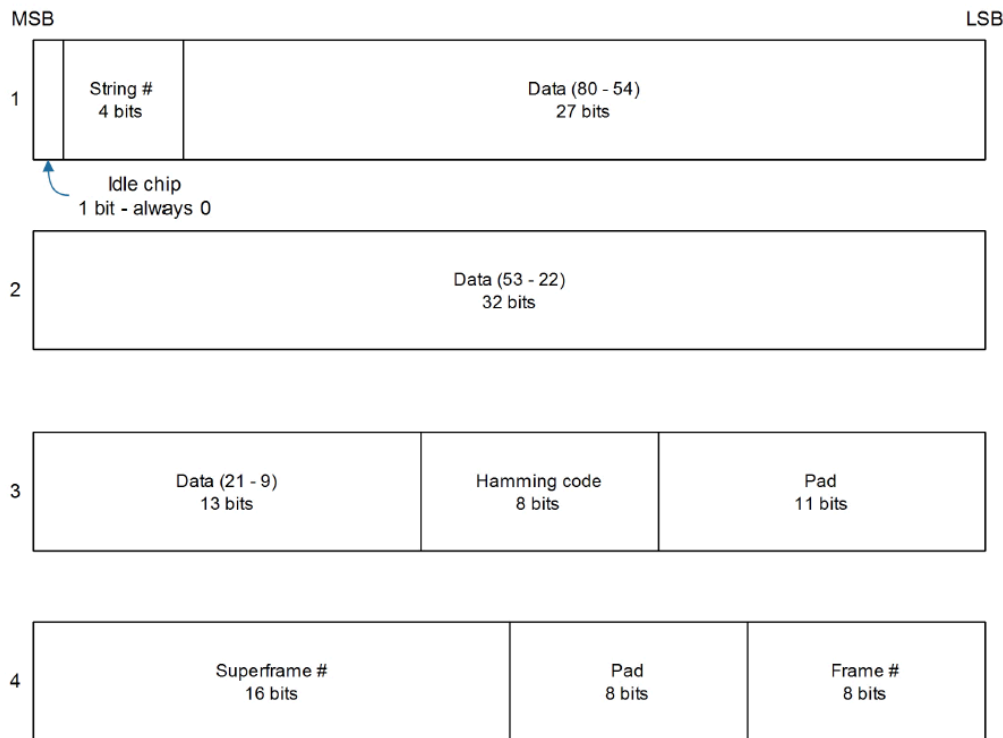

Figure 25: GLONASS subframe words

3.12.1.4 BeiDou

u-blox M9 receivers can receive and process the B1I signals broadcast at 1561.098 MHz from the BeiDou Navigation Satellite System. The ability to receive and track BeiDou signals in conjunction with another constellation results in higher coverage, improved reliability and better accuracy.

Each word is arranged as follows:

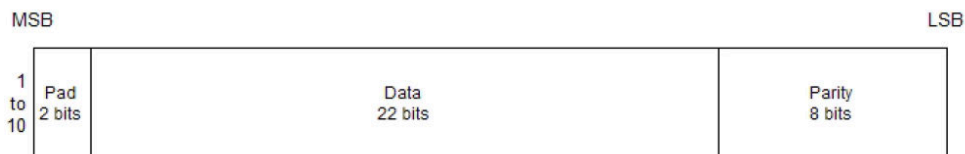

Figure 26: BeiDou subframe word

Note that as the BeiDou data words only comprise 30 bits, the 2 most significant bits in each word reported by UBX-RXM-SFRBX are padding and should be ignored.

3.12.1.5 Galileo

u-blox M9 receivers running can receive and track the E1-B/C signals centered on the GPS L1 frequency band. GPS and Galileo signals can be processed concurrently together with BeiDou and GLONASS signals, enhancing coverage, reliability and accuracy. The SAR return link message (RLM) parameters for both short and long versions are decoded by the receiver and made available to users via UBX proprietary messages and via standard NMEA RLM sentences.

3.12.1.5.1 Galileo E1 C/B

For Galileo E1 C/B signals, each reported subframe contains a pair of I/NAV pages as described in the Galileo ICD.

For Galileo "Nominal" pages the eight words are arranged as follows:

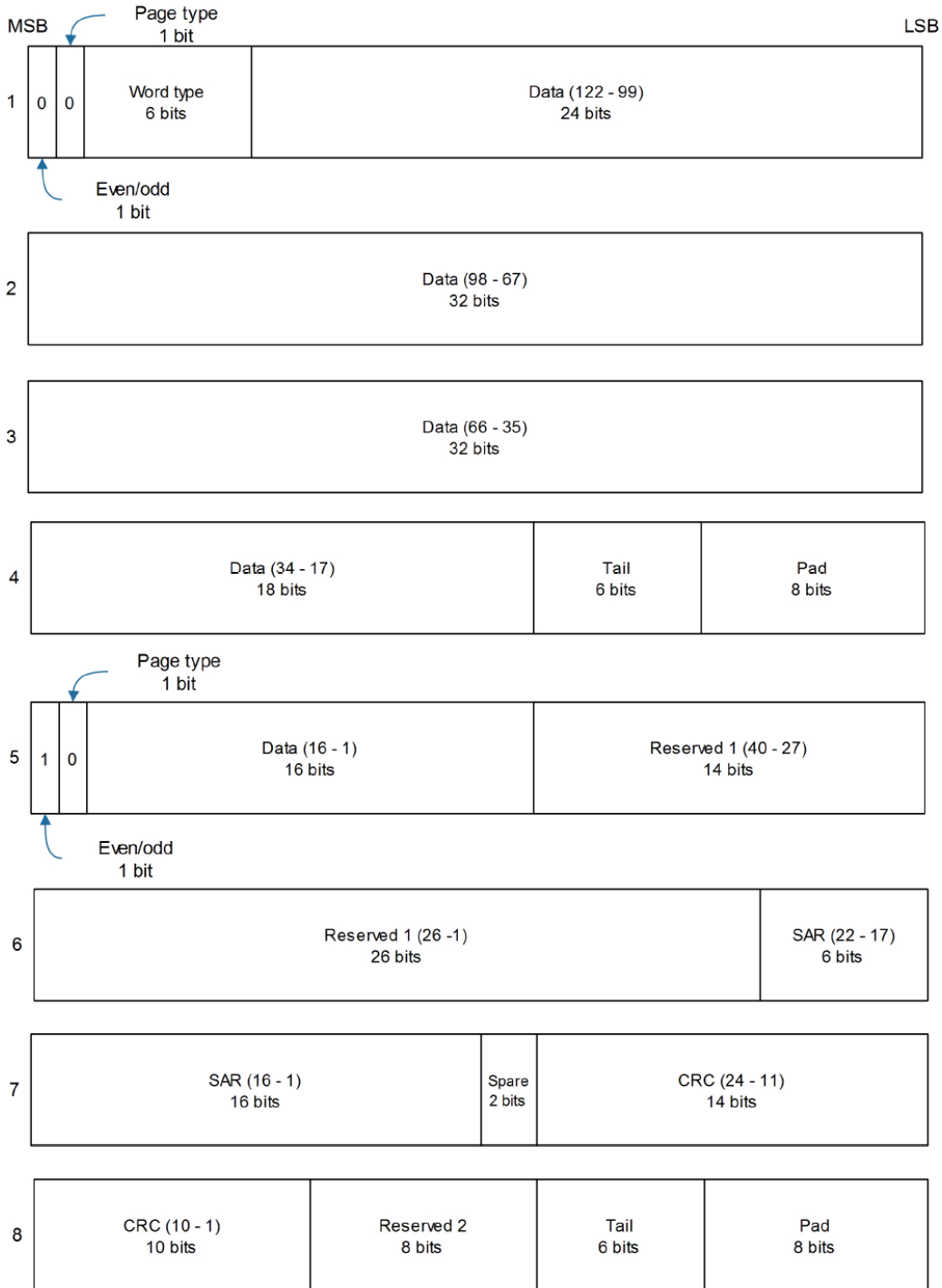

Figure 27: Galileo E1 C/B subframe words

3.12.1.6 QZSS

The structure of the data delivered by QZSS L1C/A signals is effectively identical to that for GPS (L1C/A).

3.12.1.7 Summary

The following table gives a summary of the different data message formats reported by the UBXRXM-SFRBX message:

GNSS	Signal	gnssId	sigId	numWords	period
GPS	L1C/A	0	0	10	6s
Galileo	E1 B	2	1	8	2s
BeiDou	B1I D1	3	0	10	6s
BeiDou	B1I D2	3	1	10	0.6s
QZSS	L1C/A	5	0	10	6s
GLONASS	L1OF	6	0	4	2s

Table 22: Data message formats reported by UBXRXM-SFRBX

3.13 Forcing a receiver reset

Typically, in GNSS receivers, a distinction is made between cold, warm, and hot start, depending on the type of valid information the receiver has at the time of the restart.

- **Cold start:** In cold start mode, the receiver has no information from the last position (e.g. time, velocity, frequency etc.) at startup. Therefore, the receiver must search the full time and frequency space, and all possible satellite numbers. If a satellite signal is found, it is tracked to decode the ephemeris (18-36 seconds under strong signal conditions), whereas the other channels continue to search satellites. Once there is a sufficient number of satellites with valid ephemeris, the receiver can calculate position and velocity data. Other GNSS receiver manufacturers call this startup mode **Factory startup**.
- **Warm start:** In warm start mode, the receiver has approximate information for time, position, and coarse satellite position data (Almanac). In this mode, after power-up, the receiver normally needs to download ephemeris before it can calculate position and velocity data. As the ephemeris data usually is outdated after 4 hours, the receiver will typically start with a warm start if it has been powered down for more than 4 hours. In this scenario, several augmentations are possible. See [Multiple GNSS assistance](#).
- **Hot start:** In hot start mode, the receiver was powered down only for a short time (4 hours or less), so that its ephemeris is still valid. Since the receiver does not need to download ephemeris again, this is the fastest startup method.

Using the UBXCFCGRST message, you can force the receiver to reset and clear data, in order to see the effects of maintaining/losing such data between restarts. For this, the UBXCFCGRST message offers the `navBbrMask` field, where hot, warm and cold starts can be initiated, and also other combinations thereof.

The reset type can also be specified. This is not related to GNSS, but to the way the software restarts the system.

- **Hardware reset** uses the on-chip watchdog, in order to electrically reset the chip. This is an immediate, asynchronous reset. No Stop events are generated.
- **Controlled software reset** terminates all running processes in an orderly manner and, once the system is idle, restarts operation, reloads its configuration and starts to acquire and track GNSS satellites.
- **Controlled software reset (GNSS only)** only restarts the GNSS tasks, without reinitializing the full system or reloading any stored configuration.

- **Controlled GNSS stop** stops all GNSS tasks. The receiver will not be restarted, but will stop any GNSS-related processing.
- **Controlled GNSS start** starts all GNSS tasks.

3.14 Firmware update

NEO-M9N is supplied with a fully functional firmware which has been rigorously tested and meets u-blox stringent release criteria. u-blox may release updated images containing for example, security fixes, enhancements, bug fixes etc. Therefore it is important that customers implement a firmware update mechanism in their system.

An updated firmware image has to be uploaded to the internal flash memory of the module. It then replaces the old firmware image on next receiver restart. Contact u-blox for more information on firmware update.

4 Design

This section provides information to help carry out a successful schematic and PCB design.

4.1 Pin assignment

The pin assignment of the NEO-M9N module is shown in [Figure 28](#). The defined configuration of the PIOs is listed in [Table 23](#).

13	GND	GND	12
14	LNA_EN	RF_IN	11
15	Reserved	GND	10
16	Reserved	VCC_RF	9
17	Reserved	RESET_N	8
NEO-M9N Top View			
18	SDA / SPI CS_N	VDD_USB	7
19	SCL / SPI SLK	USB_DP	6
20	TXD / SPI MISO	USB_DM	5
21	RXD / SPI MOSI	EXTINT	4
22	V_BCKP	TIMEPULSE	3
23	VCC	D_SEL	2
24	GND	SAFEBOOT_N	1

Figure 28: NEO-M9N pin assignment

Pin No	Name	I/O	Description
1	SAFEBOOT_N	I	SAFEBOOT_N (for future service, updates and reconfiguration, leave open)
2	D_SEL	I	Interface select (open or 1 = UART + I2C; 0 = SPI)
3	TIMEPULSE	O	TIMEPULSE (1 PPS)
4	EXTINT	I	EXTINT (PIO 16)
5	USB_DM	I/O	USB Data (DM)
6	USB_DP	I/O	USB Data (DP)
7	V_USB	I	USB Supply
8	RESET_N	I	RESET (active low)
9	VCC_RF	O	Voltage for external LNA
10	GND	I	Ground
11	RF_IN	I	GNSS signal input
12	GND	I	Ground
13	GND	I	Ground
14	LNA_EN	O	External LNA enable
17	EXTINT	I	External interrupt pin

Pin No	Name	I/O	Description
18	SDA / SPI CS_N	I/O	I2C data if D_SEL = 1 (or open); SPI chip select if D_SEL = 0
19	SCL / SPI SLK	I/O	I2C clock if D_SEL = 1 (or open); SPI clock if D_SEL = 0
20	TXD / SPI MISO	O	UART output if D_SEL = 1 (or open); SPI MISO if D_SEL = 0
21	RXD / SPI MOSI	I	UART input if D_SEL = 1 (or open); SPI MOSI if D_SEL = 0
22	V_BCKP	I	Backup voltage supply
23	VCC	I	Supply voltage
24	GND	I	Ground

Table 23: NEO-M9N pin assignment

4.2 NEO-M9N minimal design

The minimal electrical circuit for NEO-M9N operation using the UART1 interface is shown in [Figure 29](#) below.

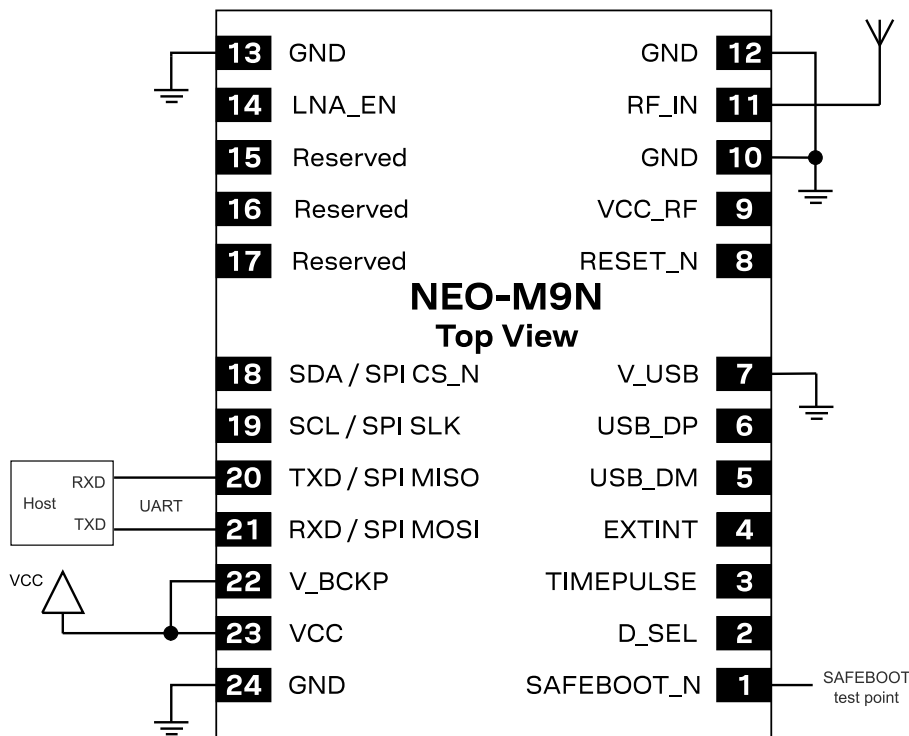
Figure 29: Minimal NEO-M9N design

For a minimal design with the NEO-M9N GNSS modules, the following functions and pins should be considered:

- Connect the power supply to VCC and V_BCKP.
- If hot or warm start operations are needed, connect a backup battery to V_BCKP.
- If USB is not used connect V_USB to ground.
- Ensure an optimal ground connection to all ground pins of the NEO-M9N GNSS module.
- Choose the required serial communication interfaces (UART, USB, SPI or I2C) and connect the appropriate pins to your application. If SPI is used D_SEL must be connected to ground.
- The NEO-M9N module includes an LNA enabling the receiver to work well with a simple passive antenna.
- SAFEBOOT_N pin can be used to enable future firmware update.

4.3 Power supply





The u-blox NEO-M9N module has three power supply pins: VCC, V_BCKP and V_USB.

(The VCC_RF pin is an output pin that can supply an active antenna or external LNA.)

4.3.1 VCC: Main supply voltage

The **VCC** pin is connected to the main supply voltage. During operation, the current drawn by the module can vary by some orders of magnitude. For this reason, it is important that the supply circuitry be able to support the peak power for a short time (see the NEO-M9N Data sheet [1] for specification).

The module integrates a DC/DC converter, which allows reduced power consumption.



-  When switching from backup mode to normal operation or at start-up, u-blox NEO-M9N modules must charge the internal capacitors in the core domain. In certain situations, this can result in a significant current draw. For low-power applications using backup mode, it is important that the power supply or low ESR capacitors at the module input can deliver this current/charge.
-  To reduce peak current during power on, users can employ an LDO that has an in-built current limiter
-  Do not add any series resistance greater than 0.2 Ω to the VCC supply as it will generate input voltage noise due to dynamic current conditions.
-  For the NEO-M9N module the equipment must be supplied by an external limited power source in compliance with the clause 2.5 of the standard IEC 60950-1.

4.3.2 V_BCKP: Backup supply voltage

The V_BCKP pin can be used to provide power to maintain the real-time clock (RTC) and battery backed RAM (BBR) when VCC is removed. Maintaining time and GNSS orbit data improves the receiver performance at startup. Especially if the RTC and BBR contents are still current, i.e. after a short VCC outage.

If V_BCKP is not provided, the module performs a cold start at power up.

If a host is connected to NEO-M9N, V_BCKP can be partially emulated by using UBX-UPD-SOS functionality. BBR data can be saved to the host and restored at startup. See [Interface description](#) for more information.

-  Avoid high resistance on the **V_BCKP** line: During the switch from main supply to backup supply, a short current adjustment peak can cause a high voltage drop on the pin with possible malfunctions.
-  If no backup supply voltage is available, connect the **V_BCKP** pin to **VCC**.
-  Allow all I/O including UART and other interfaces to float or connect to a high impedance in HW backup mode (V_BCKP supplied when VCC is removed). See the [Interfaces](#) section. It is essential that the interfaces and PIOs are isolated with open drain buffers when VCC is removed to prevent chip to be powered through these circuits.

In software backup mode the receiver remains supplied and backup is handled with software commands. See the NEO-M9N Interface description [2] for more information.

4.3.3 V_USB: USB interface power supply

V_USB supplies the USB interface. If the USB interface is not used, the V_USB pin must be connected to GND. For more information about correctly handling the V_USB pin, see [interfaces](#) section.

4.3.4 NEO-M9N power supply

The NEO-M9N standard precision GNSS receiver requires a low-noise, low-dropout voltage, very low source impedance power supply of 3.3 V typically. No inductors or ferrite beads should be used from LDO to the module VCC pin. The peak currents need to be taken into account for the source supplying the LDO for the module.

A power supply fed by 5 V is shown in the figure below. This example circuit is intended only for the module supply.

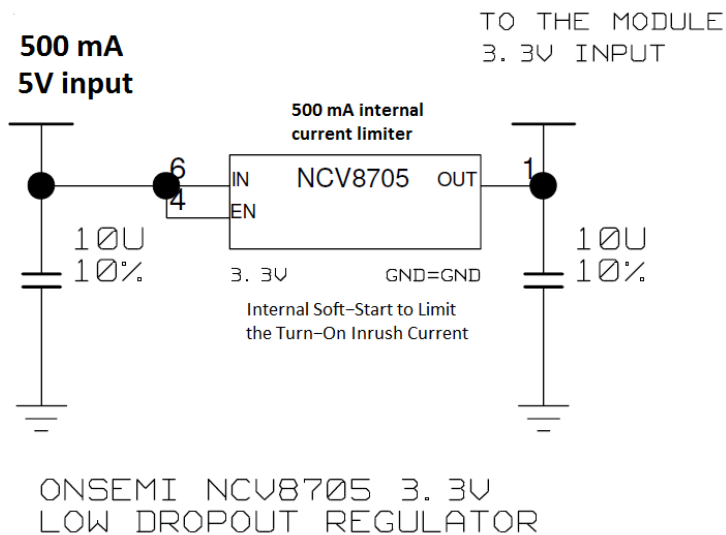

Figure 30: NEO-M9N power supply

4.4 NEO-M9N internal components

The NEO-M9N includes all necessary internal components for a complete GNSS solution.

4.4.1 Clock generation

The NEO-M9N includes a stable and clean TCXO oscillator for frequency generation to provide good GNSS performance.

4.4.2 Real time clock (RTC)

The NEO-M9N module includes a real time clock (RTC). The RTC section is located in the backup domain and used to maintain time in the event of power failure at the main supply (VCC). In the case of a power failure at VCC, the backup domain is supplied by V_BCKP. The RTC enables hot start, warm start, AssistNow Autonomous, AssistNow Offline and on/off operation of the power save mode.

4.4.2.1 Time aiding feature

Current time can also be sent by UBX message on startup of the receiver. If time will be aided after restarting the receiver, e.g. wake-up from backup mode, then the time kept by the internal RTC is not used. To enable hot starts, the time information must be provided accurately and thus the time mark feature must be used. The time aiding and time mark features are described in the NEO-M9N Interface description [2].



Time aiding cannot be applied when using the power save mode operations, because the host does not have any information when the GNSS receiver turns from OFF status to ON status during on/off operation of the power save mode.

4.4.3 SAW and LNA

The NEO-M9N module includes a SAW filter, an LTE band 13 notch filter and a low-noise amplifier (LNA) to reduce external RF interference and to improve GNSS signal reception sensitivity.

4.4.4 VCC_RF antenna bias voltage

The NEO-M9N module can provide filtered power to external antenna or external LNA via the VCC_RF output pin.

4.4.5 Flash memory

NEO-M9N includes an internal flash memory that can be used to store the firmware image, save logging data or save the AssistNow Offline data. How to enable these services and functions is described in the corresponding chapters of the [Receiver functionality](#).

4.5 Antenna

GNSS signals operate with very low signal levels, ranging from -120 dBm to about -167 dBm. This is already a quite challenging parameter for GNSS receiver performance. In addition to that the fact that out-of-band interferers such as GSM, CDMA, WCDMA, WiFi or Bluetooth wireless systems have a much higher signal level makes the receiver layout even more challenging.

Performance of the GNSS antenna and the related front-end RF signal path components have a decisive impact on the performance of the overall GNSS application. The NEO-M9N module includes a SAW filter, an LTE band 13 notch filter and an LNA to reduce external RF interference and to improve GNSS signal reception sensitivity. The SAW filter is before the LNA in the RF path. This decreases sensitivity to out-of-band interference and also prevents the LNA from getting into saturation by very strong interferers.

The included LNA and SAW filter enable the NEO-M9N module to work well with an inexpensive passive antenna. For applications where passive antenna performance is not sufficient, the NEO-M9N module supports controlling and supplying an external LNA or active antenna. For example, u-blox ANN-MS high-performance active GPS antenna has suitable out-of-band filtering, low noise-figure and good amplification for all L-band frequencies from 1550 to 1620 MHz.

4.5.1 Antenna design with passive antenna

A design using a passive antenna requires attention to the layout of the RF section. Typically, a passive antenna is located near electronic components; therefore, care should be taken to reduce electrical noise that may interfere with the antenna performance. The antenna must have sufficient bandwidth to receive all needed GNSS constellations. Also, a suitable ground plane is required for

¹ GNSS system bandwidths: 1559... 1563 MHz; 1573... 1578 MHz; 1598... 1606 MHz;

the antenna to achieve good performance. Passive antennas do not require a DC bias voltage and can be directly connected to the RF input pin RF_IN. A passive antenna may need a passive matching network to match the impedance to 50 Ω .

The example circuit in [Figure 31](#) shows a setup for a design with a good passive GNSS antenna.

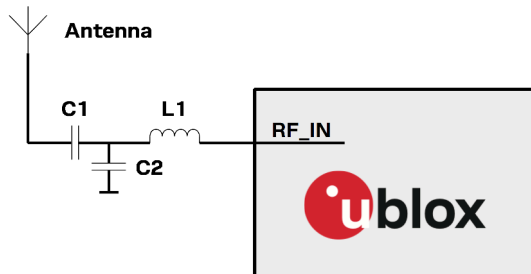

Figure 31: Passive antenna example circuit with optional 50 Ω matching network

In the figure above the capacitor C1 is a RF-input DC block. This component is optional as the NEO-M9N already has an internal DC block at RF_IN pin. The capacitor C2 and inductor L1 compose the 50 Ω RF-input matching network.

4.5.2 Antenna design with external LNA or active antenna

Passive antenna may be inadequate if the antenna gain is low or if the antenna must be placed far away from the module. For such designs the NEO-M9N module supports controlling an additional external LNA or active antenna. The antenna control signal pin LNA_EN is active high to enable the external LNA or active antenna when the receiver needs GNSS signal. If needed, the VCC_RF output pin can be used to supply filtered DC bias voltage to these external components. In this case the supply voltage of the NEO-M9N module must match the external components' working voltage (e.g. 3.3 V). If the VCC_RF voltage does not match with the supply voltage of the active antenna, use a filtered external supply.

An external LNA or active antenna with an integrated LNA requires a power supply that contributes an additional current of typically 5 to 20 mA to the system's power consumption budget.

Active antennas for GNSS application are usually powered through a DC bias on the RF cable. A simple bias-T as in [Figure 32](#) can be used to add this DC current to the RF signal line. The bias voltage can be supplied either by the VCC_RF pin of the module or by an external antenna supply.

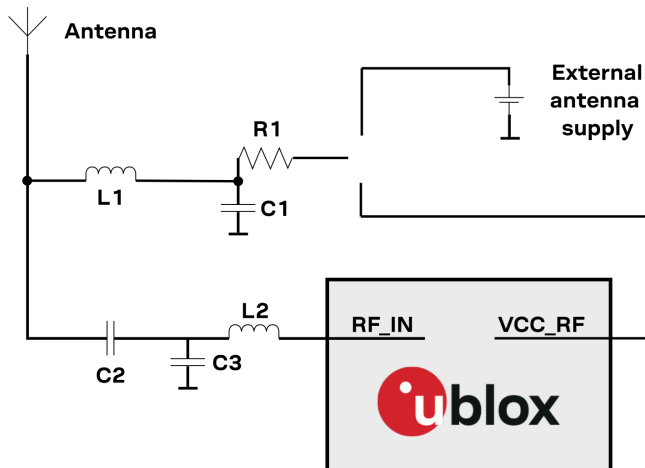
Figure 32: NEO-M9N active antenna example circuit (Bias-T)

Part	Recommended value	Description
C1	X7R 100 nF 10% 16 V	Bias-T capacitor removes high frequency noise coming from the DC supply.
L1	27 nH, impedance > 500 Ω at GNSS frequency, rated current > 300 mA	Bias-T inductor isolates RF from the DC path.
L2; C3	8.2 nH 2%; COG 2.2 pF 25 V	Optional 50 Ω RF-input matching network. Component values depend on the application. Not needed if the antenna and RF trace are already matched to 50 Ω .
C2	COG 47 pF 5% 25 V	Optional DC block to protect RF-input. The NEO-M9N module has an internal DC block at RF_IN pin.
R1	10 Ω 10% 0.25 W	Current limiter series resistor in the event of a short circuit.

Table 24: Components in active antenna example circuit (Bias-T)

Design recommendations:

- If the application has a passive antenna with sufficient gain but the antenna is located far away from the module, an additional external LNA must be placed close to the passive antenna.
- If the application needs an active antenna, it is recommended to use an OEM active antenna module meeting u-blox's specification.
- A suitable ground plane is required for the antenna to achieve good performance.
- Active antenna may have strong gain. For maximum external gain see the Data sheet [1] in Related documents.
- A series current limiting resistor is required to prevent short-circuits destroying the bias-t inductor.
- If the VCC_RF voltage of the NEO-M9N module does not match the supply voltage of the active antenna, use a filtered external supply instead of the VCC_RF.
- The antenna circuit should include filtering to ensure adequate protection from interference by nearby transmitters. Take care in the design of circuit of antennas placed close to cellular or Wi-Fi transmitting antennas.
- An ESD protection diode should also be connected to the input.

It is recommended to use active current limiting. If active current limiting is not used, the following important points covered below need to be taken into account:



The bias-t inductor and current limiting resistor must be selected to be reliable with a short-circuit on the antenna feed. In the case where the module supplies the voltage via VCC_RF,

a higher value resistor will be needed to ensure the module supply inductor is protected. The current should be limited to below 150 mA at the module supply voltage under short-circuit conditions. For example, a value of 19 Ω or more is required at a module supply of 3.3 V to limit short-circuit current to 150 mA. The DC resistance of the bias-t inductor is assumed to be 1-2 Ω and the module internal feed inductor is assumed to be 1.2 Ω .



The power dissipation in the resistor and inductor needs to be taken into account based on the supply voltage and short-circuit current.

4.6 EOS/ESD precautions

When integrating GNSS receivers into wireless systems, careful consideration must be given to electromagnetic and voltage susceptibility issues. Wireless systems include components which can produce Electrostatic Discharge (ESD), Electrical Overstress (EOS) and Electro-Magnetic Interference (EMI). CMOS devices are more sensitive to such influences because their failure mechanism is defined by the applied voltage, whereas bipolar semiconductors are more susceptible to thermal overstress. The following design guidelines are provided to help in designing robust yet cost-effective solutions.



To avoid overstress damage during production or in the field it is essential to observe strict EOS/ESD/EMI handling and protection measures.



To prevent overstress damage at the RF_IN of your receiver, never exceed the maximum input power as specified in the u-blox NEO-M9N Data sheet [1].

4.6.1 ESD protection measures



GNSS receivers are sensitive to Electrostatic Discharge (ESD). Special precautions are required when handling. Most defects caused by ESD can be prevented by following strict ESD protection rules for production and handling. When implementing passive antenna patches or external antenna connection points, then additional ESD measures as shown in the figure below can also avoid failures in the field.

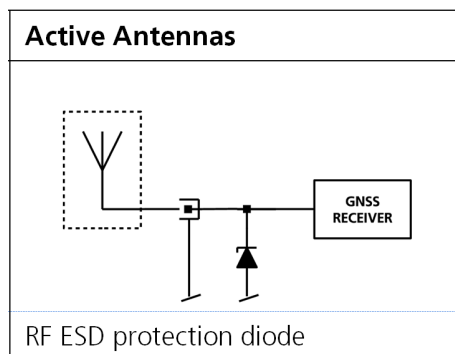

Figure 33: RF ESD precautions

4.6.2 EOS precautions

Electrical overstress (EOS) usually describes situations when the maximum input power exceeds the maximum specified ratings. EOS failure can happen if RF emitters are close to a GNSS receiver or its antenna. EOS causes damage to the chip structures. If the RF_IN is damaged by EOS, it is hard to determine whether the chip structures have been damaged by ESD or EOS.

EOS protection measures as shown in the figure below are recommended for any designs combining wireless communication transceivers (e.g. GSM, GPRS) and GNSS in the same design or in close proximity.

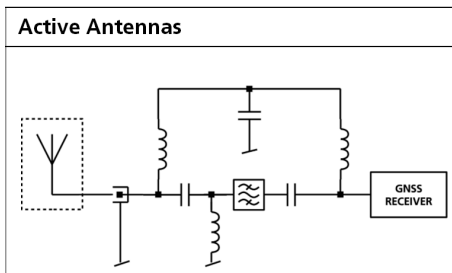

Figure 34: Active antenna EOS protection

4.6.3 Safety precautions

The NEO-M9N must be supplied by an external limited power source in compliance with the clause 2.5 of the standard IEC 60950-1. In addition to external limited power source, only Separated or Safety Extra-Low Voltage (SELV) circuits are to be connected to the module including interfaces and antennas.



For more information about SELV circuits see section 2.2 in Safety standard IEC 60950-1.

4.7 Electromagnetic interference on I/O lines

Any I/O signal line with a length greater than approximately 3 mm can act as an antenna and may pick up arbitrary RF signals transferring them as noise into the GNSS receiver. This specifically applies to unshielded lines, in which the corresponding GND layer is remote or missing entirely, and lines close to the edges of the printed circuit board.

If, for example, a cellular signal radiates into an unshielded high-impedance line, it is possible to generate noise in the order of volts and not only distort receiver operation but also damage it permanently. Another type of interference can be caused by noise generated at the PIO pins that emits from unshielded I/O lines. Receiver performance may be degraded when this noise is coupled into the GNSS antenna.

EMI protection measures are particularly useful when RF emitting devices are placed next to the GNSS receiver and/or to minimize the risk of EMI degradation due to self-jamming. An adequate layout with a robust grounding concept is essential in order to protect against EMI.



Intended Use: In order to mitigate any performance degradation of a radio equipment under EMC disturbance, system integration shall adopt appropriate EMC design practice and not contain cables over three meters on signal and supply ports.

4.7.1 General notes on interference issues

Received GNSS signal power at the antenna is very low. At the nominal received signal strength (-128 dBm) it is below the thermal noise floor of -111 dBm. Due to this fact, a GNSS receiver is susceptible to interference from nearby RF sources of any kind. Two cases can be distinguished:

- **Out-of-band interference:** Typically any kind of wireless communications system (e.g. LTE, GSM, CDMA, 3G, WLAN, Bluetooth, etc.) may emit its specified maximum transmit power in close proximity to the GNSS receiving antenna, especially if such a system is integrated with the GNSS receiver. Even at reasonable antenna selectivity, destructive power levels may reach the RF input of the GNSS receiver. Also, larger signal interferers may generate intermodulation products inside the GNSS receiver front-end that fall into the GNSS band and contribute to in-band interference
- **In-band interference:** Although the GNSS band is kept free from intentional RF signal sources by radio-communications standards, many devices emit RF power into the GNSS band at levels

much higher than the GNSS signal itself. One reason is that the frequency band above 1 GHz is not well regulated with regards to EMI, and even if permitted, signal levels are much higher than GNSS signal power. Notably, all types of digital equipment, such as PCs, digital cameras, LCD screens, etc. tend to emit a broad frequency spectrum up to several GHz of frequency. Also wireless transmitters may generate spurious emissions that fall into GNSS band

As an example, GSM uses power levels of up to 2 W (+33 dBm). The absolute maximum power input at the RF input of the GNSS receiver can be +15 dBm. The GSM specification allows spurious emissions for GSM transmitters of up to +36 dBm, while the GNSS signal is less than -128 dBm. By simply comparing these numbers it is obvious that interference issues must be seriously considered in any design of a GNSS receiver. Different design goals may be achieved through different implementations:

- The primary focus is preventing the destruction of the receiver from large input signals. Here the GNSS performance under interference conditions is not important and suppression of the GNSS signal is permitted. It is sufficient to just observe the maximum RF power ratings of all the components in the RF input path.
- GNSS performance must be guaranteed even under interference conditions. In that case, not only the maximum power ratings of the components in the receive patch must be observed. Further, non-linear effects like gain compression, NF degradation (desensitization) and intermodulation must be analyzed.



Pulsed interference with a low duty cycle such as GSM may be destructive due to the high peak power levels.

4.7.2 In-band interference mitigation

With in-band interference, the signal frequency is very close to the GNSS frequency. Such interference signals are typically caused by harmonics from displays, micro-controller operation, bus systems, etc. Measures against in-band interference include:

- Maintaining a good grounding concept in the design
- Shielding
- Layout optimization
- Low-pass filtering of noise sources, e.g. digital signal lines
- Remote placement of the GNSS antenna, far away from noise sources
- Adding an LTE, CDMA, GSM, WCDMA, BT band-pass filter before antenna

4.7.3 Out-of-band interference

Out-of-band interference is caused by signal frequencies that are different from the GNSS carrier frequency. The main sources are wireless communication systems such as LTE, GSM, CDMA, WCDMA, Wi-Fi, BT, etc.

Measures against out-of-band interference include maintaining a good grounding concept in the design and adding a GNSS band-pass filter into the antenna input line to the receiver.

For GSM applications, such as typical handset design, an isolation of approximately 20 dB can be reached with careful placement of the antennas. If this is insufficient, an additional SAW filter is required on the GNSS receiver input to block the remaining GSM transmitter energy.

4.8 Layout

This section details layout and placement requirements of the NEO-M9N standard precision GNSS receiver.

4.8.1 Placement

GNSS signals at the surface of the Earth are below the thermal noise floor. A very important factor in achieving maximum GNSS performance is the placement of the receiver on the PCB. The placement used may affect RF signal loss from antenna to receiver input and enable interference into the sensitive parts of the receiver chain, including the antenna itself. When defining a GNSS receiver layout, the placement of the antenna with respect to the receiver, as well as grounding, shielding and interference from other digital devices are crucial issues and need to be considered very carefully.

Signal loss on the RF connection from antenna to receiver input must be minimized as much as possible. Hence, the connection to the antenna must be kept as short as possible.

Ensure that RF critical circuits are clearly separated from any other digital circuits on the system board. To achieve this, position the receiver digital part closer to the digital section of the system PCB and have the RF section and antenna placed as far as possible away from the other digital circuits on the board.

A proper GND concept shall be followed: The RF section shall not be subject to noisy digital supply currents running through its GND plane.

Care must also be exercised with placing the receiver in proximity to circuitry that can emit heat. The RF part of the receiver is very sensitive to temperature and sudden changes can have an adverse impact on performance.



The TCXO of a GNSS receiver is a temperature-sensitive device. Avoid high temperature drift and air convection.

4.8.2 Package footprint, copper and paste mask

Copper and solder mask dimensioning recommendations for the NEO-M9N module packages are provided in this section.



These are recommendations only and not specifications. The exact copper, solder and paste mask geometries, distances, stencil thicknesses and solder paste volumes must be adapted to the specific production processes (e.g. soldering etc.) of the customer.

Refer to the NEO-M9N Data sheet [1] for the mechanical dimensions.

4.8.2.1 Mechanical dimensions

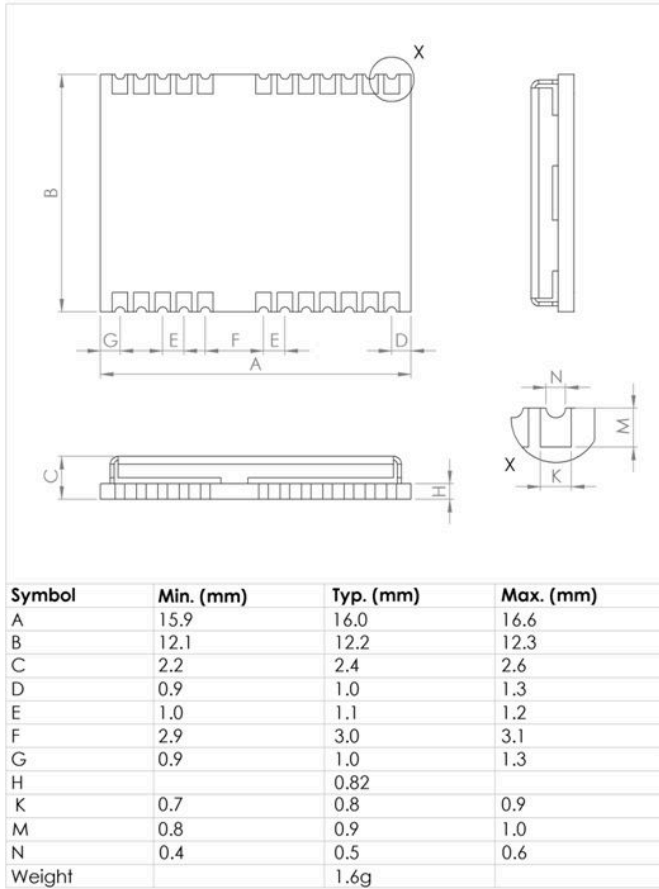

Figure 35: NEO-M9N mechanical dimensions

4.8.2.2 Footprint

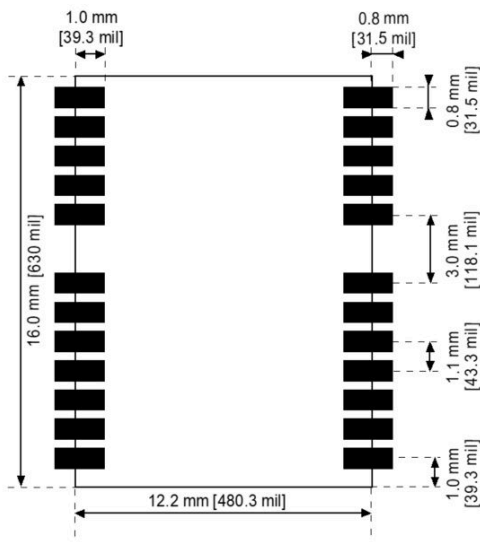

Figure 36: NEO-M9N suggested footprint (i.e. copper mask)

4.8.2.3 Paste mask

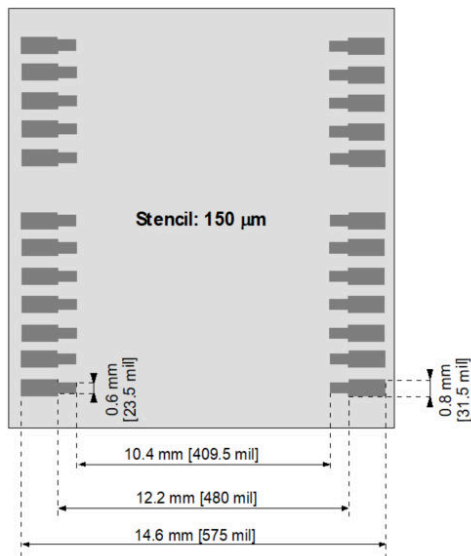

Figure 37: NEO-M9N suggested paste mask

4.8.3 Layout guidance

The presented layout guidance reduces the risk of performance issues at design level.

4.8.3.1 RF In trace

The RF In trace has to work in the middle L-band frequencies.

A grounded co-planar RF trace is recommended as it provides the maximum shielding from noise with adequate vias to the ground layer.

Focus on these layout guidelines:

- RF input co-planar waveguide referenced to layer 2, matched to 50 Ω .
- Place RF input matching component close to RF_IN pin.
- Use vias to 3D grounding at ground plane.
- No stubs must occur on the RF input trace.

The RF trace must be shielded by vias to ground along the entire length of the trace and the NEO-M9N RF_IN pad should be surrounded by vias as shown in the figure below.

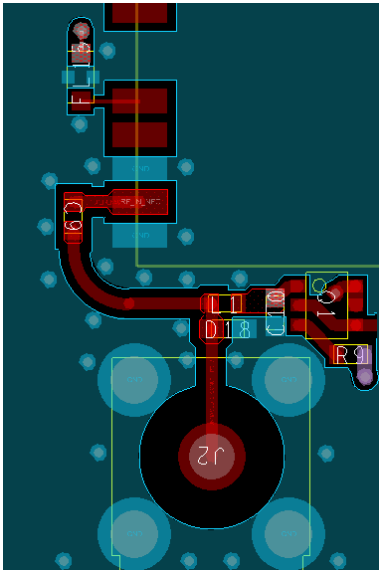

Figure 38: RF input trace

The RF_IN trace on the top layer should be referenced to a suitable ground layer.

4.8.3.2 VCC pad

The VCC pad for the NEO-M9N standard precision GNSS receiver needs to have as low an impedance as possible with large vias to the lower power layer of the PCB. The VCC pad needs a large pad and the decoupling capacitor must be placed as close as possible. This is shown in the figure below.

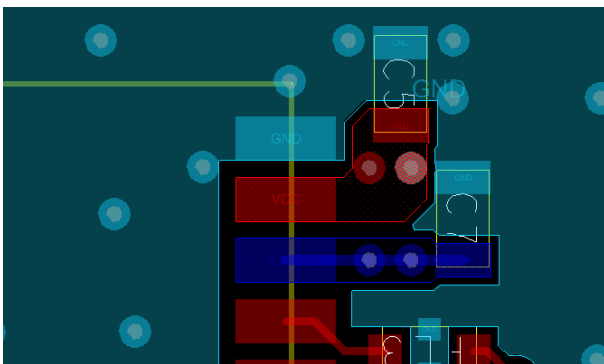

Figure 39: VCC pad

4.9 Design guidance

4.9.1 General considerations

Check power supply requirements and schematic:

- Is the power supply voltage within the specified range and noise-free?
- If USB is not used, connect the V_USB pin to ground.
- For USB devices: Is the V_USB voltage within the specified range?
- It is recommended to have a separate LDO for V_USB that is enabled by the module VCC. This is to comply with the USB self-powered specification.
- If USB is used, is there a 1 uF capacitor right near the V_USB pin? This is just for the V_USB pin.
- Is there a 1 uF cap right next to the module VCC pin?

- Compare the peak current consumption of the NEO-M9N GNSS module with the specification of your power supply.
- GNSS receivers require a stable power supply. Avoid series resistance (less than 0.2 Ω) in your power supply line (the line to VCC) to minimize the voltage ripple on VCC. See the NEO-M9N [Power supply](#) section in the [Design](#) chapter for more information on the power supply requirements.
- Allow all I/O to Float/High impedance (High-Z) when VCC is not applied.

4.9.2 Backup battery

Check backup supply requirements and schematic:

- For achieving a minimal Time To First Fix (TTFF) after a power down (warm starts, hot starts), make sure to connect a backup battery to V_BCKP.
- Verify your battery backup supply can provide the battery backup current specified in the NEO-M9N datasheet.
- Allow all I/O including UART and other interfaces to Float/High impedance in HW backup mode (battery back-up connected with VCC removed).

4.9.3 RF front-end circuit options

The first stages of the signal processing chain are crucial to the overall receiver performance.

When an RF input connector is employed this can provide a conduction path for harmful or destructive electrical signals. If this is a likely factor the RF input should be protected accordingly.

Additional points on the RF input

- What is the expected quality of the signal source (antenna)?
- What is the external active antenna signal power?
- What is the bandwidth and filtering of the external active antenna?
- Does the external antenna and any optional filtering components meet the group delay variation requirements?

Are destructive RF power levels expected to reach the RF input? Is interference from wireless transmitters expected?

- What are the characteristics of these signals (duty cycle, frequency range, power range, spectral purity)?
- What is the expected GNSS performance under interference conditions?

Is there a risk of RF input exposure to excessive ESD stress?

- In the field: Can the user access the antenna connector?
- PCB / system assembly: Is there risk that statically charged parts (e.g. patch antennas) may be discharged through the RF-input?

The following subsections provide several options addressing the various questions above:



In some applications, such as cellular transceivers, interference signals may exceed the maximum power rating of the RF_IN input. To avoid device destruction use of external input protection is mandatory.



During assembly of end-user devices which contain passive patch antennas, an ESD discharge may occur during production when pre-charged antennas are soldered to the GNSS receiver board. In such cases, use of external protection in front of RF_IN is mandatory to avoid device destruction.

ESD discharge cannot be avoided during assembly and / or field use. Note that SAW filters are susceptible to ESD damage. To provide additional robustness an ESD protection diode may be placed at the antenna RF connector to GND.

4.9.4 Antenna/RF input

Check RF input requirements and schematic:

- Make sure the antenna is not placed close to noisy parts of the circuitry and does not face any other noisy elements (for example micro-controller, display).
- ESD protection on the RF input is mandatory.
- Possible external antenna bias-t inductor must be L-band frequency selected with high impedance in the GNSS band.
- Ensure RF trace is tuned for 50 Ω to ensure proper GNSS bandwidth.

4.9.5 Ground pads

Ensure the ground pads of the module are connected to ground.

If a patch type antenna is used, a sufficient antenna ground plane is required.

4.9.6 Schematic design

For a **minimal design** with the NEO-M9N GNSS modules, consider the following functions and pins:

- Connect the power supply to VCC and V_BCKP.
- V_USB: If USB is used it is recommended V_USB is to be powered as per USB self-powered mode specification.
- If USB is not used connect V_USB to ground.
- Ensure an optimal ground connection to all ground pins of the NEO-M9N GNSS module.
- Choose the required serial communication interfaces (UART, USB, SPI or I2C) and connect the appropriate pins to your application.
- If you need hot or warm start in your application, connect a back-up battery to V_BCKP.

4.9.7 Layout design-in guideline

- Is the receiver placed away from heat sources?
- Is the receiver placed away from air-cooling sources?
- Is the receiver shielded by a cover/case to prevent the effects of air currents and rapid environmental temperature changes?
- Is the receiver placed as recommended in the [Layout](#) and [Layout guidance](#)?
- Assure a low serial resistance on the VCC power supply line (choose a line width > 400 μm).
- Keep the power supply line as short as possible.
- Add a ground plane underneath the module to reduce interference. This is especially important for the RF input line.
- For improved shielding, add as many vias as possible around the micro strip/co-planar waveguide, around the serial communication lines, underneath the module, etc.

5 Product handling

5.1 ESD handling precautions



NEO-M9N contain highly sensitive electronic circuitry and are Electrostatic Sensitive Devices (ESD). Observe precautions for handling! Failure to observe these precautions can result in severe damage to the GNSS receiver!

- Unless there is a galvanic coupling between the local GND (i.e. the work table) and the PCB GND, then the first point of contact when handling the PCB must always be between the local GND and PCB GND.
- Before mounting an antenna patch, connect ground of the device.



Connect first
to local GND

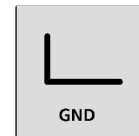

- When handling the RF pin, do not come into contact with any charged capacitors and be careful when contacting materials that can develop charges (e.g. patch antenna ~10 pF, coax cable ~50-80 pF/m or soldering iron).



ESD Sensitive!

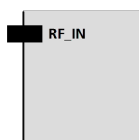

- To prevent electrostatic discharge through the RF input, do not touch any exposed antenna area. If there is any risk that such exposed antenna area is touched in non-ESD protected work area, implement proper ESD protection measures in the design.

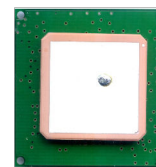

- When soldering RF connectors and patch antennas to the receiver's RF pin, make sure to use an ESD safe soldering iron (tip).



ESD safe only!



5.2 Soldering

Soldering paste

Use of “no clean” soldering paste is highly recommended, as it does not require cleaning after the soldering process has taken place. The paste listed in the example below meets these criteria.

- Soldering paste: OM338 SAC405 / Nr.143714 (Cookson Electronics)
- Alloy specification: Sn 95.5/ Ag 4/ Cu 0.5 (95.5% Tin/ 4% Silver/ 0.5% Copper)
- Melting temperature: 217 °C
- Stencil thickness: The exact geometry, distances, stencil thicknesses and solder paste volumes must be adapted to the specific production processes (e.g. soldering) of the customer

Reflow soldering

A convection-type soldering oven is highly recommended over the infrared type radiation oven. Convection-heated ovens allow precise control of the temperature, and all parts will heat up evenly, regardless of material properties, thickness of components and surface color.

As a reference, see the “IPC-7530 Guidelines for temperature profiling for mass soldering (reflow and wave) processes”, published in 2001.

Preheat phase

During the initial heating of component leads and balls, residual humidity will be dried out. Note that this preheat phase will not replace prior baking procedures.

- Temperature rise rate: max. 3 °C/s. If the temperature rise is too rapid in the preheat phase it may cause excessive slumping
- Time: 60 – 120 s. If the preheat is insufficient, rather large solder balls tend to be generated. Conversely, if performed excessively, fine balls and large balls will be generated in clusters
- End temperature: 150 – 200 °C. If the temperature is too low, non-melting tends to be caused in areas containing large heat capacity

Heating - reflow phase

The temperature rises above the liquidus temperature of 217°C. Avoid a sudden rise in temperature as the slump of the paste could become worse.

- Limit time above 217 °C liquidus temperature: 40 – 60 s
- Peak reflow temperature: 245 °C

Cooling phase

A controlled cooling prevents negative metallurgical effects (solder becomes more brittle) of the solder and possible mechanical tensions in the products. Controlled cooling helps to achieve bright solder fillets with a good shape and low contact angle.

- Temperature fall rate: max 4 °C/s



To avoid falling off, the modules should be placed on the topside of the motherboard during soldering.

The final soldering temperature chosen at the factory depends on additional external factors such as the choice of soldering paste, size, thickness and properties of the base board, etc. Exceeding the maximum soldering temperature in the recommended soldering profile may permanently damage the module.

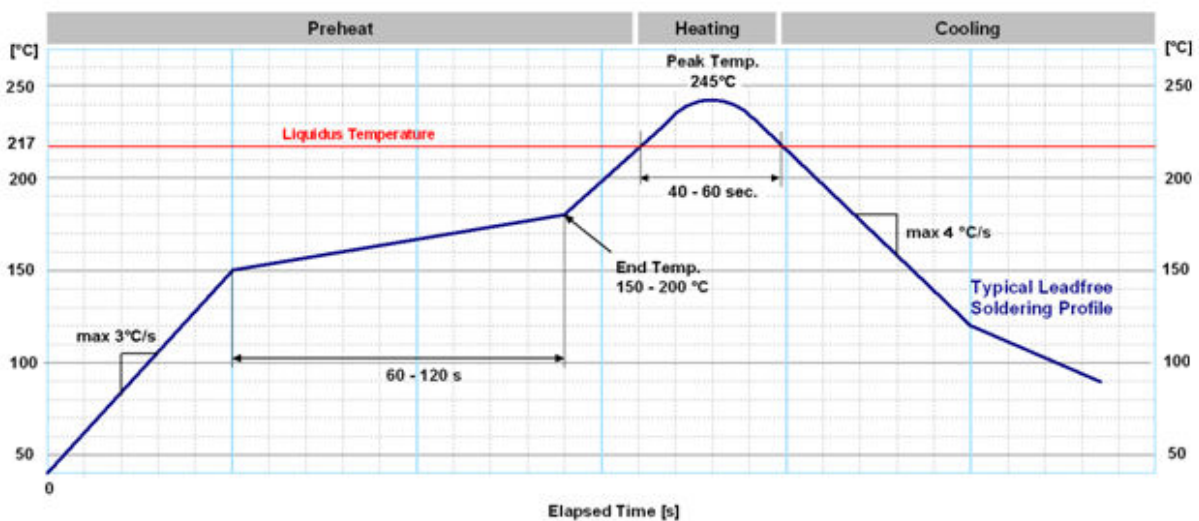



Figure 40: Soldering Profile

 Modules **must not** be soldered with a damp heat process.

Optical inspection

After soldering the module, consider an optical inspection step.

Cleaning

 No cleaning with water, solvent, ultrasonic cleaner should be carried out:

- Cleaning with water will lead to capillary effects where water is absorbed in the gap between the baseboard and the module. The combination of residues of soldering flux and encapsulated water leads to short circuits or resistor-like interconnections between neighboring pads.
- Cleaning with alcohol or other organic solvents can result in soldering flux residues flooding into the two housings, areas that are not accessible for post-wash inspections. The solvent will also damage the sticker and the ink-jet printed text.
- Ultrasonic cleaning will permanently damage the module, in particular the quartz oscillators.

The best approach is to use a "No Clean" soldering paste and eliminate the cleaning step after the soldering.

Repeated reflow soldering

Only single reflow soldering processes are recommended for boards populated with modules. Modules should not be submitted to two reflow cycles on a board populated with components on both sides in order to avoid upside down orientation during the second reflow cycle. In this case, the module should always be placed on that side of the board, which is submitted into the last reflow cycle. The reason for this (besides others) is the risk of the module falling off due to the significantly higher weight in relation to other components.

Two reflow cycles can be considered by excluding the above described upside down scenario and taking into account the rework conditions described in this section.

 Repeated reflow soldering processes and soldering the module upside down are not recommended.

Wave soldering

Base boards with combined through-hole technology (THT) components and surface-mount technology (SMT) devices require wave soldering to solder the THT components. Only a single wave soldering process is encouraged for boards populated with modules.

Rework

We do not recommend using a hot air gun because this is an uncontrolled process and might damage the module.

 Use of a hot air gun can lead to overheating and severely damage the module. Always avoid overheating the module.

After the module is removed, clean the pads before re-applying solder paste, placing and reflow soldering a new module.

 Never attempt a rework on the module itself, e.g. replacing individual components. Such actions immediately terminate the warranty.

Conformal coating

Certain applications employ a conformal coating of the PCB using HumiSeal® or other related coating products. These materials affect the RF properties of the GNSS module and it is important

to prevent them from flowing into the module. The RF shields do not provide 100% protection for the module from coating liquids with low viscosity; therefore, care is required in applying the coating.

 Conformal coating of the module will void the warranty.

Casting

If casting is required, use viscose or another type of silicon pottant. The OEM is strongly advised to qualify such processes in combination with the module before implementing this in the production.

 Casting will void the warranty.

Grounding metal covers

Attempts to improve grounding by soldering ground cables, wick or other forms of metal strips directly onto the EMI covers is done at the customer's own risk. The numerous ground pins should be sufficient to provide optimum immunity to interferences and noise.

 u-blox makes no warranty for damages to the module caused by soldering metal cables or any other forms of metal strips directly onto the EMI covers.

Use of ultrasonic processes

Some components on the module are sensitive to ultrasonic waves. Use of any ultrasonic processes (cleaning, welding etc.) may cause damage to the GNSS receiver.

 u-blox offers no warranty against damages to the module caused by any ultrasonic processes.

5.3 Packaging

The NEO-M9N modules are delivered as hermetically sealed, reeled tapes in order to enable efficient production, production lot set-up and tear-down. For more information about packaging, see the u-blox Package Information Guide [3].

5.4 Reels

The NEO-M9N GNSS modules are deliverable in quantities of 250 pieces on a reel. The modules are shipped on Reel Type B, as specified in the u-blox Package Information Guide. See the u-blox Package Information Guide [3].

5.5 Tapes

Figure 41 shows the feed direction and illustrates the orientation of the NEO-M9N on the tape:

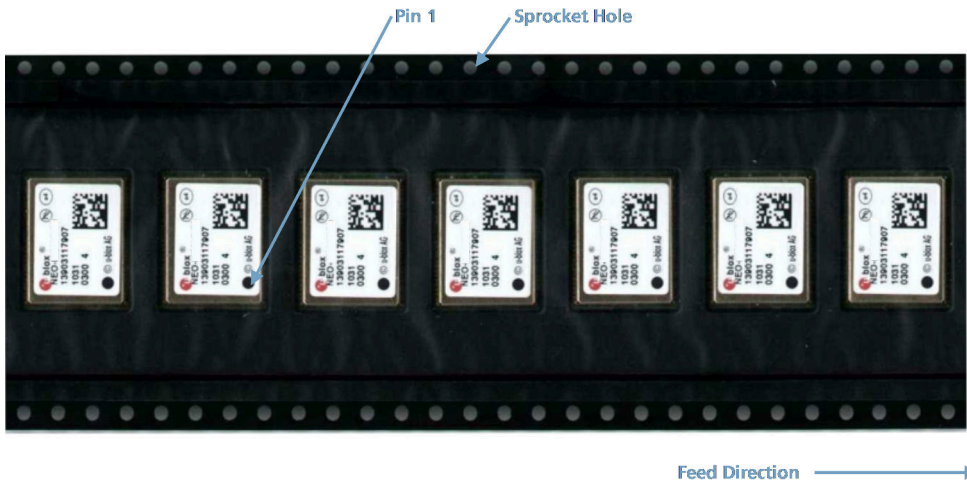

Figure 41: Orientation of NEO-M9N on the tape

The dimensions of the tapes for NEO-M9N receivers are specified in Figure 42 (measurements in mm).

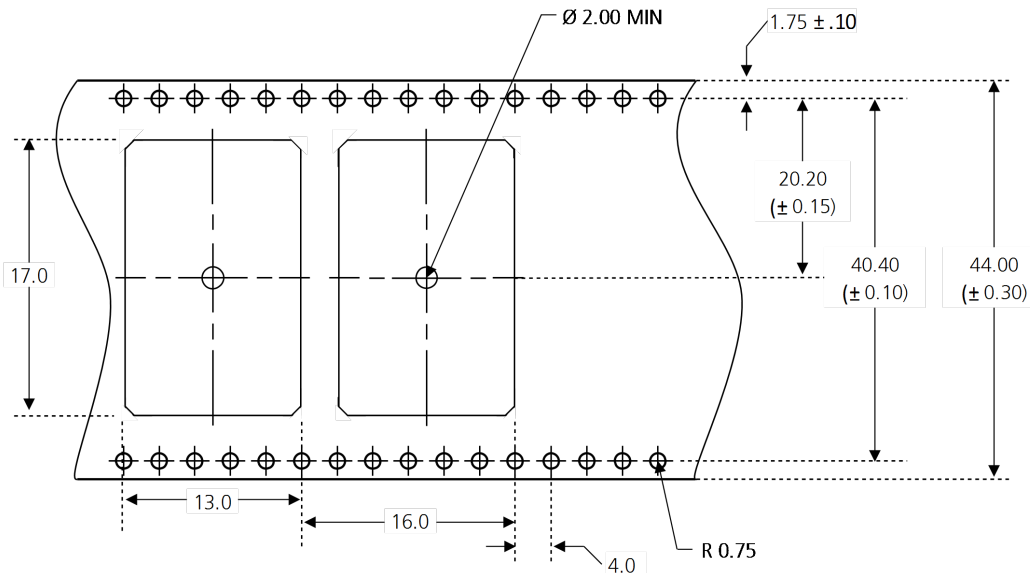

Figure 42: NEO-M9N tape dimensions (mm)

5.6 Moisture sensitivity levels

The moisture sensitivity level (MSL) for NEO-M9N is specified in the table below.

Package	MSL level
LCC	4

Table 25: MSL level



For MSL standard see IPC/JEDEC J-STD-020, which can be downloaded from www.jedec.org.



For more information regarding moisture sensitivity levels, labeling, storage and drying, see the u-blox Package Information Guide [3].

Appendix

A Migration

u-blox is committed to ensuring that products in the same form factor are backwards compatible over several technology generations. Utmost care has been taken to ensure there is no negative impact on function or performance and to make the new u-blox M9 series modules as fully compatible as possible with previous generation modules. The new u-blox M9 generation contains many hardware and firmware enhancements. Some of these enhancements have impact on customer application design. It is highly advisable that customers consider a design review with the u-blox support team to ensure the proper use of key functionalities.

When designing with the new u-blox M9 generation the following topics should be considered:

- Power supply range is 2.7 V – 3.6 V. Using lower or higher voltage may break the device.
- Power consumption of the module is slightly higher than in the previous u-blox 8/M8 generation. Make sure that the power supply is able to provide clean and stable voltage even with this higher current demand.
- External IO isolation is mandatory. Removing the VCC supply does not isolate the IO pins of the module from the IO pins on the application host side. If the IO pins are not isolated the receivers operation will be undefined and the GNSS receiver may even be permanently damaged if the current drawn from the IO pins gets very high.
- Digital IO pin output voltage in the NEO-M9N Data sheet[1] Operating conditions is defined with current of 2 mA. In previous u-blox 8/M8 generation the levels were defined with current of 4 mA.
- UART baud rate is 38'400 baud. In previous u-blox receiver generations the default baud rate has been 9'600 baud. NEO-M9N can track large amount of satellites and reports their state with the calculated navigation solution (PVT) once per second as NMEA or UBX messages. Bandwidth of at least 38'400 baud is needed to transfer all of this data within one second. If 9'600 baud rate is needed for backwards compatibility then some of the default NMEA or UBX messages must be disabled first.
- Selected pin names have been updated to agree with a common naming convention across u-blox modules. The pins have not changed their operation and are the same physical hardware but with updated names.
- NEO-M9N supports simultaneous use of GPS, GLONASS, Galileo, BeiDou, and various SBAS constellations. Make sure that the RF path (antenna and filtering) is suitable for all of the used GNSS signals.

B Glossary

Abbreviation	Definition
ANSI	American National Standards Institute
ARP	Antenna Reference Point
BeiDou	Chinese navigation satellite system
BBR	Battery Backed RAM
CDMA	Code Division Multiple Access
I2C	Inter-Integrated Circuit bus
EMC	Electromagnetic Compatibility
EMI	Electromagnetic Interference
EOS	Electrical Overstress

Abbreviation	Definition
EPA	Electrostatic Protective Area
ESD	Electrostatic Discharge
Galileo	European navigation satellite system
GLONASS	Russian navigation satellite system
GND	Ground
GNSS	Global Navigation Satellite System
GPS	Global Positioning System
GSM	Global System for Mobile Communications
IEC	International Electrotechnical Commission
PCB	Printed Circuit Board
RF	Radio frequency
SBAS	Satellite Based Augmentation System
SV	Space Vehicle, a satellite
UBX	u-blox
QZSS	Quasi-Zenith Satellite System

Related documents

- [1] NEO-M9N Data sheet, doc. no. UBX-19014285
- [2] NEO-M9N Interface description, doc. no. UBX-19035940
- [3] u-blox Package Information Guide, doc. no. UBX-14001652



For regular updates to u-blox documentation and to receive product change notifications please register on our homepage (<http://www.u-blox.com>).

Revision history

Revision	Date	Name	Status / Comments
R01	28-Nov-2019	jesk	Advance information

Contact

For complete contact information visit us at www.u-blox.com.

u-blox Offices

North, Central and South America

u-blox America, Inc.

Phone: +1 703 483 3180
E-mail: info_us@u-blox.com

Regional Office West Coast

Phone: +1 408 573 3640
E-mail: info_us@u-blox.com

Technical Support

Phone: +1 703 483 3185
E-mail: support_us@u-blox.com

Headquarters

Europe, Middle East, Africa

u-blox AG

Phone: +41 44 722 74 44
E-mail: info@u-blox.com
Support: support@u-blox.com

Asia, Australia, Pacific

u-blox Singapore Pte. Ltd.

Phone: +65 6734 3811
E-mail: info_ap@u-blox.com
Support: support_ap@u-blox.com

Regional Office Australia

Phone: +61 2 8448 2016
E-mail: info_anz@u-blox.com
Support: support_ap@u-blox.com

Regional Office China (Beijing)

Phone: +86 10 68 133 545
E-mail: info_cn@u-blox.com
Support: support_cn@u-blox.com

Regional Office China (Chongqing)

Phone: +86 23 6815 1588
E-mail: info_cn@u-blox.com
Support: support_cn@u-blox.com

Regional Office China (Shanghai)

Phone: +86 21 6090 4832
E-mail: info_cn@u-blox.com
Support: support_cn@u-blox.com

Regional Office China (Shenzhen)

Phone: +86 755 8627 1083
E-mail: info_cn@u-blox.com
Support: support_cn@u-blox.com

Regional Office India

Phone: +91 80 4050 9200
E-mail: info_in@u-blox.com
Support: support_in@u-blox.com

Regional Office Japan (Osaka)

Phone: +81 6 6941 3660
E-mail: info_jp@u-blox.com
Support: support_jp@u-blox.com

Regional Office Japan (Tokyo)

Phone: +81 3 5775 3850
E-mail: info_jp@u-blox.com
Support: support_jp@u-blox.com

Regional Office Korea

Phone: +82 2 542 0861
E-mail: info_kr@u-blox.com
Support: support_kr@u-blox.com

Regional Office Taiwan

Phone: +886 2 2657 1090
E-mail: info_tw@u-blox.com
Support: support_tw@u-blox.com