

# 37D Metal Gearmotors



Pololu 37D Metal Gearmotors are powerful brushed DC motors paired with 37mm-diameter gearboxes. There are nine different gearbox options available, ranging from 6.3:1 to 150:1, and two different motor options: 12 V and 24 V. The 24 V versions offer approximately the same speed and torque at 24 V as their 12 V counterparts do at 12 V, with approximately half the current draw. This datasheet includes two sets of performance graphs for each version, one at its nominal voltage and one at half of its nominal voltage. Each version is available with an integrated 64 CPR quadrature encoder on the motor shaft.

Note: The original versions of these gearmotors had gearboxes with all spur gears. In August 2019, these were replaced by functionally identical “Helical Pinion” versions that feature helical gears for the first stage of the gearbox, which reduces noise and vibration and improves efficiency. The picture on the right shows the helical pinion gear and first mating gear.



## Performance summary and table of contents

Rated Voltage	Pololu Item #	Gear Ratio	No Load		At Maximum Efficiency				Max Power	Stall Extrapolation <sup>(2)</sup>		Graph Pages	
			Speed	Current	Speed	Torque	Current	Output		Torque	Current		
			:1	RPM	A	RPM	kg-mm	A		W	kg-mm		A
12 V	4750 <sup>(1)</sup>	1	10,000							5			
	4747, 4757	6.25	1600		1300	4.9	1.2	6.4	12	30		5, 6	
	4748, 4758	10	1000		850	6.6	0.91	5.7	12	49		7, 8	
	4741, 4751	18.75	530		470	10	0.76	5.0	12	85		9, 10	
	4742, 4752	30	330	0.2	280	18	0.78	5.1	12	140	5.5	11, 12	
	4743, 4753	50	200		180	22	0.66	4.0	10	210		13, 14	
	4744, 4754	70	150		130	32	0.68	4.2	10 <sup>(3)</sup>	270		15, 16	
	4745, 4755	102.08	100		87	42	0.72	3.8	8 <sup>(3)</sup>	340		17, 18	
	4746, 4756	131.25	76		66	60	0.74	4.1	6 <sup>(3)</sup>	450		19, 20	
	2828, 2829	150	67		58	65	0.72	3.8	6 <sup>(3)</sup>	490		21, 22	
4690 <sup>(1)</sup>	1	10,000								5.5			
4688, 4698	6.25	1600			1300	5.5	0.58	7.4	14	35			23, 24
4689, 4699	10	1000			850	7.5	0.49	6.6	14	55			25, 26
4681, 4691	18.75	530			450	13	0.49	6.1	13	95			27, 28
24 V	4682, 4692	30	330	0.1	280	19	0.46	5.5	13	150	3.0	29, 30	
	4683, 4693	50	200		170	27	0.41	4.9	12	230		31, 32	
	4684, 4694	70	140		120	39	0.42	5.0	10 <sup>(3)</sup>	310		33, 34	
	4685, 4695	102.08	100		86	51	0.42	4.5	8 <sup>(3)</sup>	390		35, 36	
	4686, 4696	131.25	79		68	63	0.40	4.4	6 <sup>(3)</sup>	470		37, 38	
	4687, 4697	150	68		59	73	0.41	4.4	6 <sup>(3)</sup>	560		39, 40	

### Notes:

- (1) Max efficiency data and performance graphs currently unavailable for the motors without gearboxes (items #4750 and #4690).
- (2) Listed stall torques and currents are theoretical extrapolations; units will typically stall well before these points as the motors heat up. Stalling or overloading gearmotors can greatly decrease their lifetimes and even result in immediate damage. The recommended upper limit for continuously applied loads is 100 kg-mm, and the recommended upper limit for instantaneous torque is 250 kg-mm. Stalls can also result in rapid (potentially on the order of seconds) thermal damage to the motor windings and brushes; a general recommendation for brushed DC motor operation is 25% or less of the stall current.
- (3) Output power for these units is constrained by gearbox load limits; spec provided is output power at max recommended load of 100 kg-mm.

# 37D Metal Gearmotors



## Dimensions (units: mm over [inches])

Gearmotor versions without encoders (items #2829, 4681–4689, 4741–4748)

weight: 175 g to 195 g

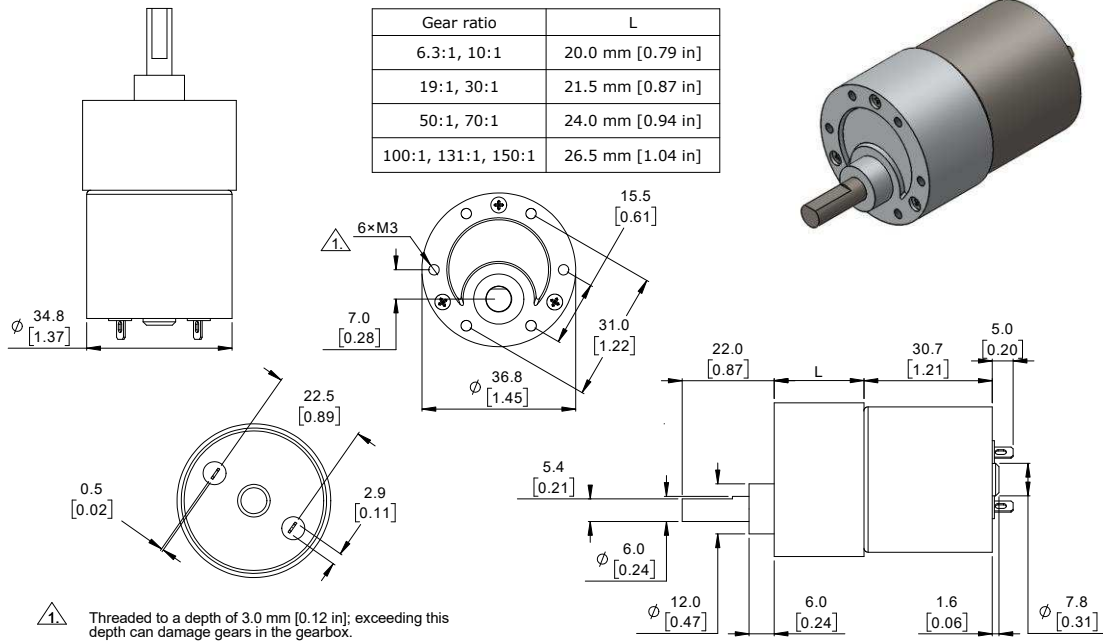

Gearmotor versions with encoders (items #2828, 4691–4699, 4751–4758)

weight: 190 g to 210 g

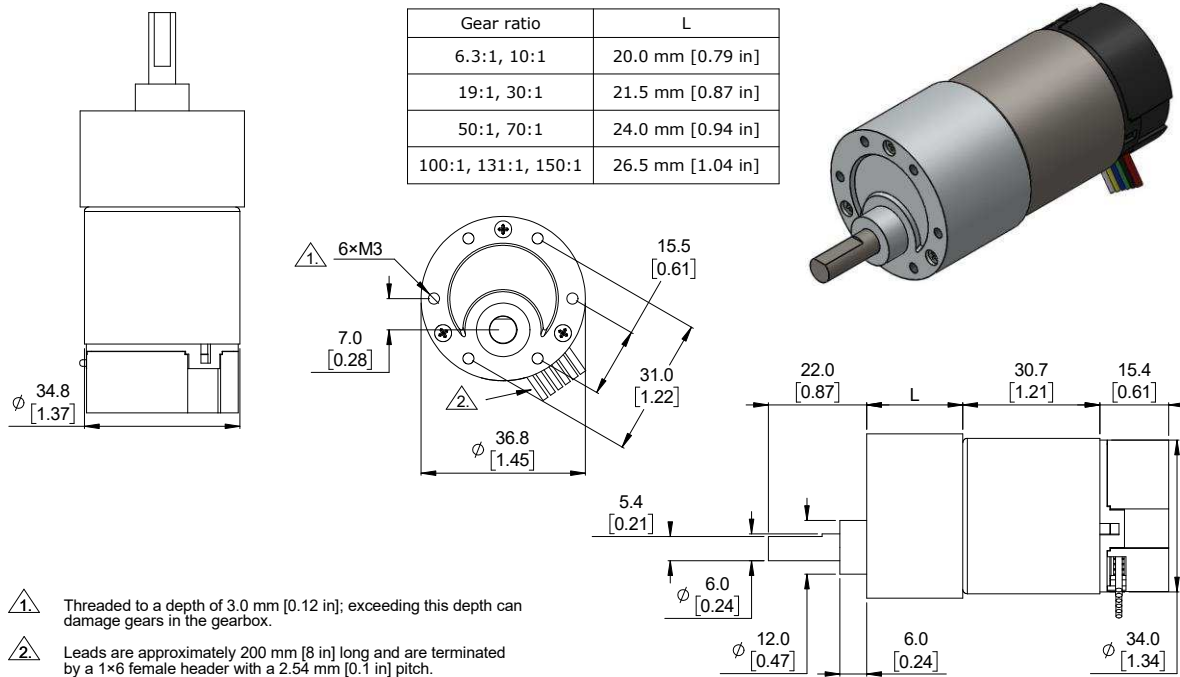

# 37D Metal Gearmotors



Motor with encoder and no gearbox (items #4690, 4750)

weight: 110 g

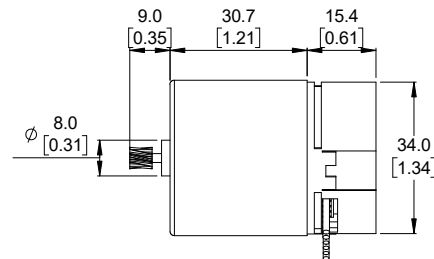
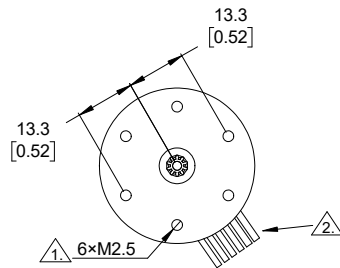
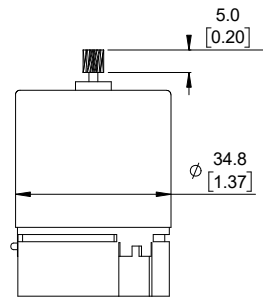

- 1. Threaded to a depth of 3.5 mm [0.14 in]; exceeding this depth can damage the motor.
- 2. Leads are approximately 200 mm [8 in] long and are terminated by a 1×6 female header with a 2.54 mm [0.1 in] pitch.

## Using the encoder

Versions with encoders have additional electronics mounted on the rear of the motor. Two Hall-effect sensors are used to sense the rotation of a magnetic disc on a rear protrusion of the motor shaft. The encoder electronics and magnetic disc are enclosed by a removable plastic end cap. The following pictures show what the encoder portion looks like with the end cap removed:



The quadrature encoder provides a resolution of 64 counts per revolution (CPR) of the motor shaft when counting both edges of both channels. To compute the counts per revolution of the gearbox output, multiply the gear ratio by 64.

The motor/encoder has six color-coded, 20 cm (8") leads terminated by a 1×6 female connector with a 2.54 mm (0.1") pitch. This connector works with standard 0.1" male breakaway headers and Pololu male premium jumper and precrimped wires. If this header is not convenient, the crimped wires can be pulled out of the 1×6 housing and used with different crimp connector housings instead (e.g. 1×2 for the motor power and 1×1 housings for the other four leads), or the connectors can be cut off entirely.

# 37D Metal Gearmotors



Lead Color	Function
Red	Motor power
Black	Motor power
Green	Encoder ground
Blue	Encoder Vcc (3.5 V to 20 V)
Yellow	Encoder A output
White	Encoder B output

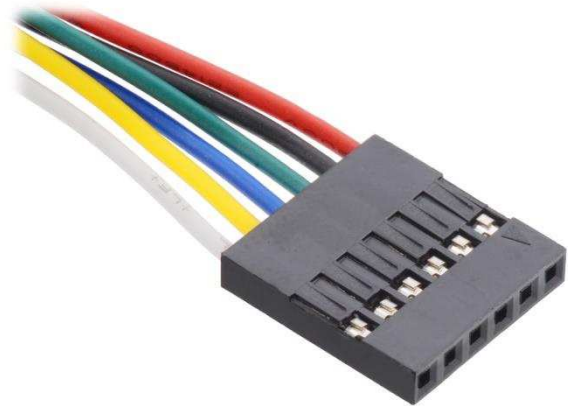

The Hall sensors require an input voltage, Vcc, between 3.5 V and 20 V and draw a maximum of 10 mA. The A and B outputs are square waves from 0 V to Vcc approximately 90° out of phase. The speed of the motor can be determined from the frequency, and the direction of rotation can be determined from the order of the transitions. The following oscilloscope capture shows the A and B (yellow and white) encoder outputs using a 12 V motor at 12 V and a Hall sensor Vcc of 5 V:

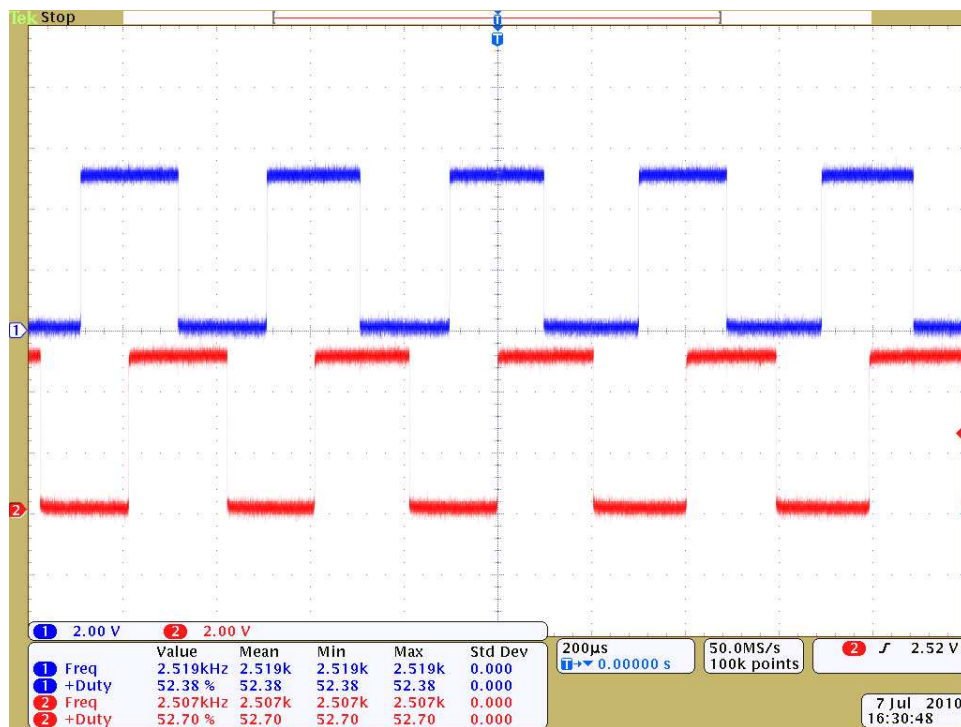

Counting both the rising and falling edges of both the A and B outputs results in 64 counts per revolution of the motor shaft. Using just a single edge of one channel results in 16 counts per revolution of the motor shaft, so the frequency of the A output in the above oscilloscope capture is 16 times the motor rotation frequency.

# Pololu Items #4747, #4757 (6.3:1 Metal Gearmotor 37D 12V) Performance at 12 V

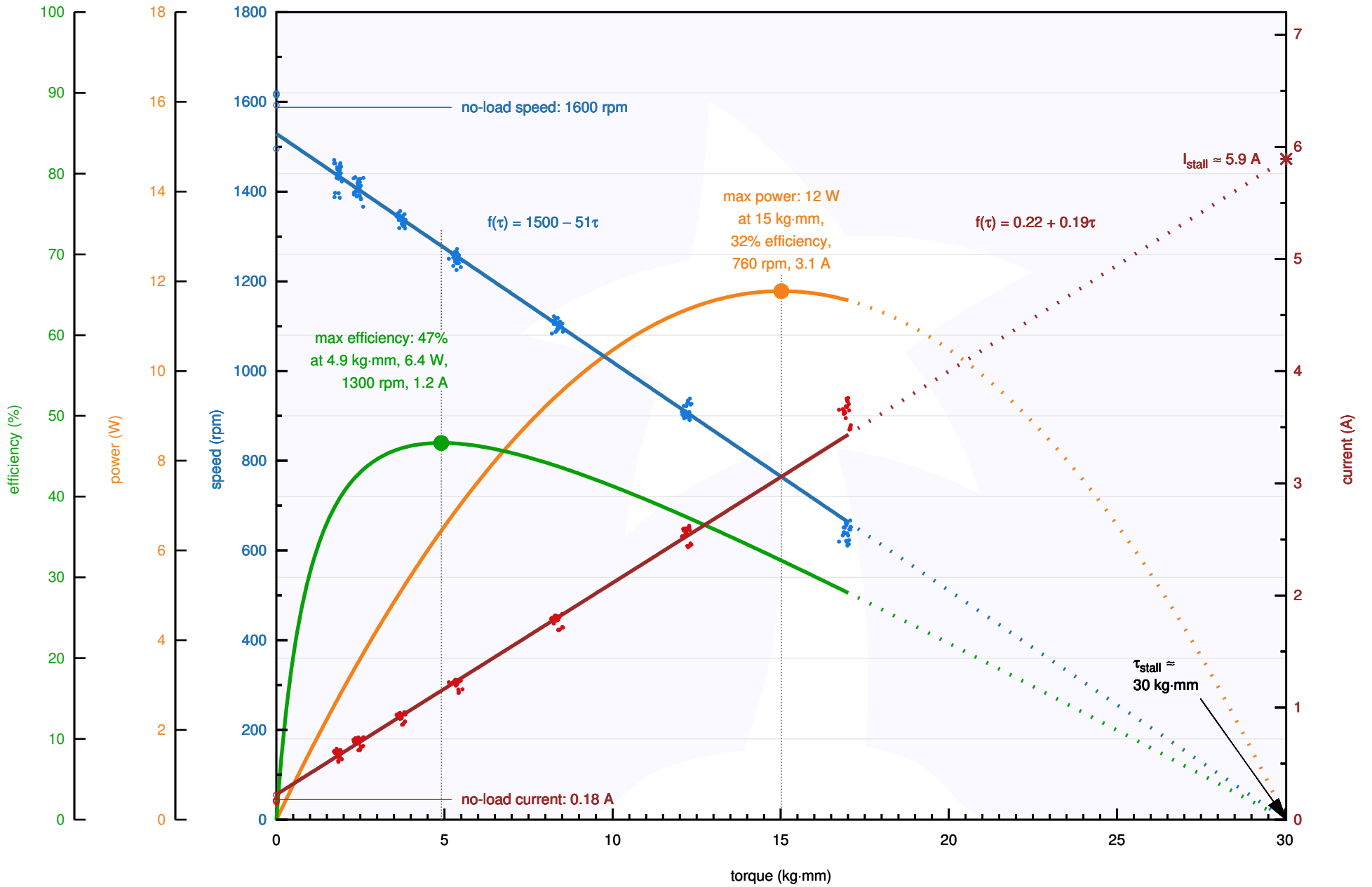

# Pololu Items #4747, #4757 (6.3:1 Metal Gearmotor 37D 12V) Performance at 6 V

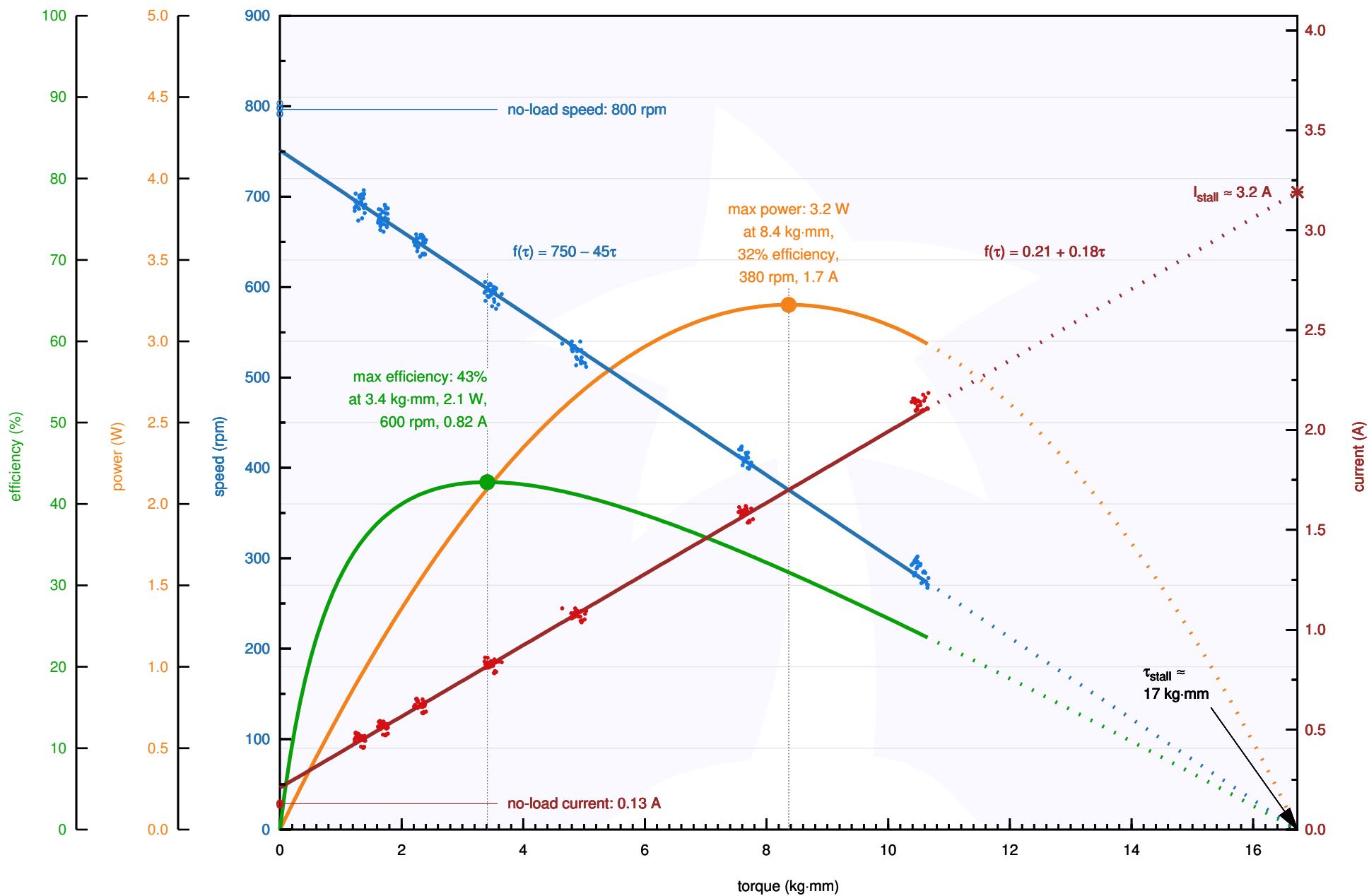

# Pololu Items #4748, #4758 (10:1 Metal Gearmotor 37D 12V) Performance at 12 V

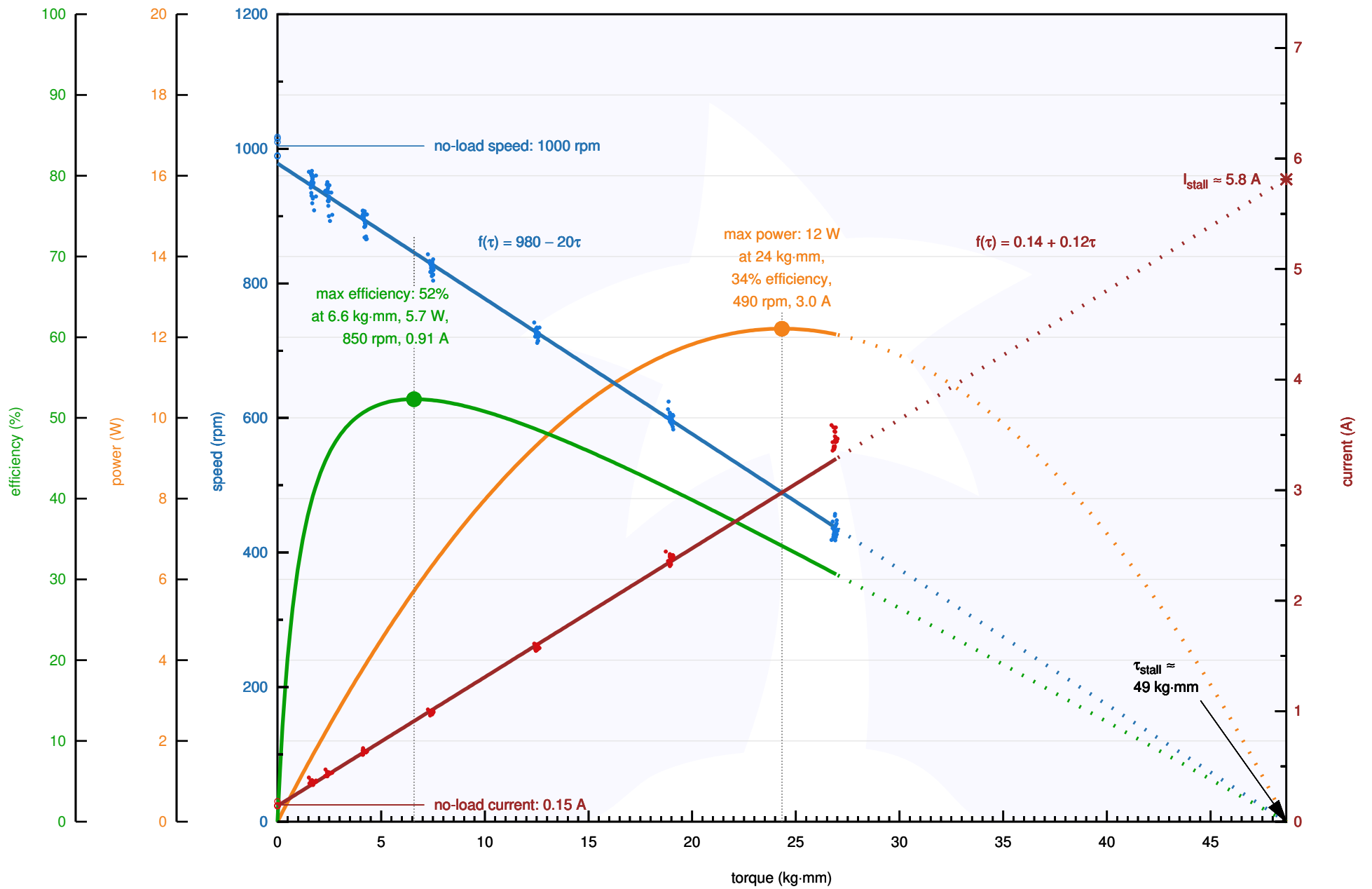

# Pololu Items #4748, #4758 (10:1 Metal Gearmotor 37D 12V) Performance at 6 V

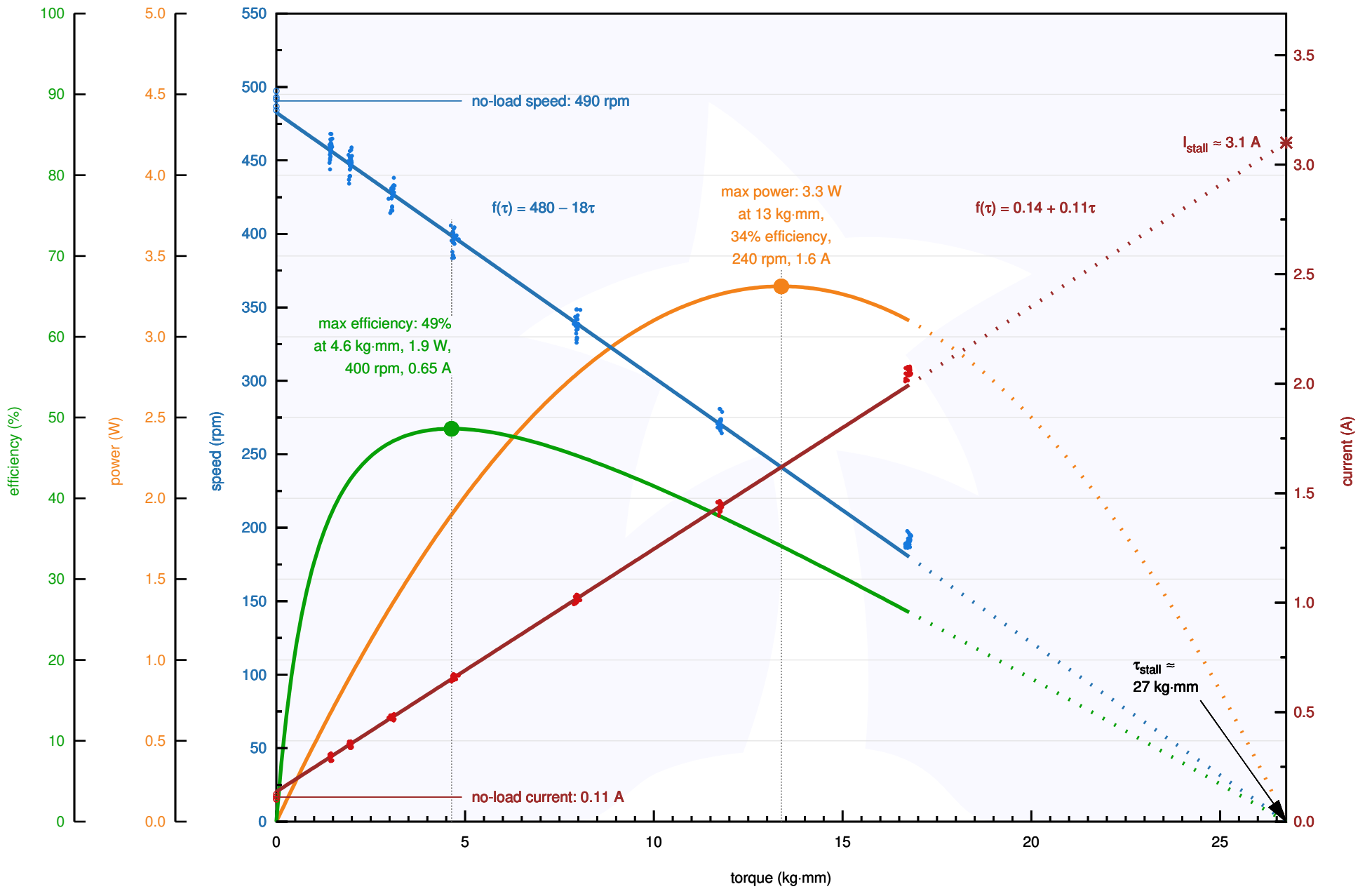



# Pololu Items #4741, #4751 (19:1 Metal Gearmotor 37D 12V) Performance at 12 V

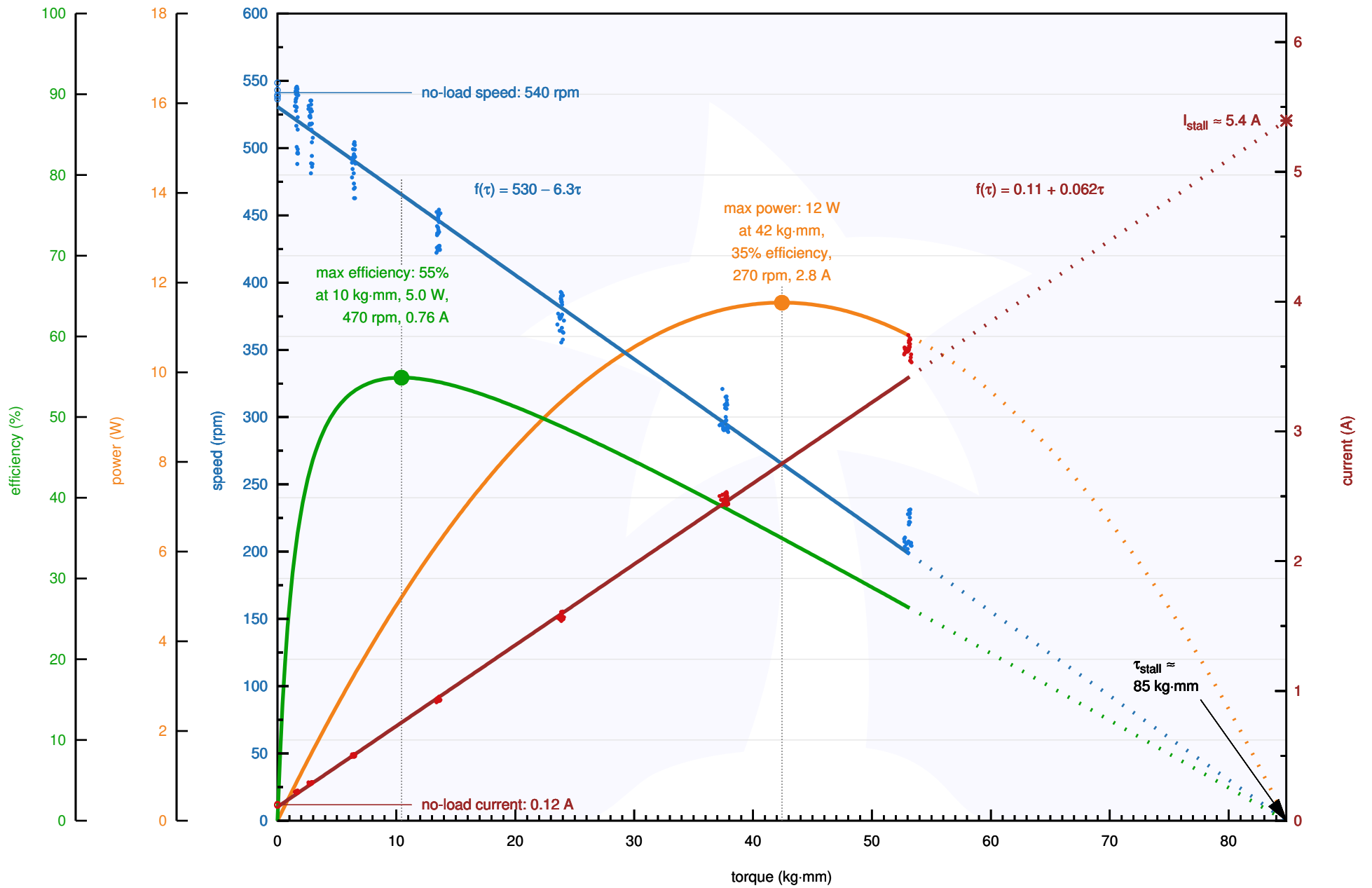

# Pololu Items #4741, #4751 (19:1 Metal Gearmotor 37D 12V) Performance at 6 V

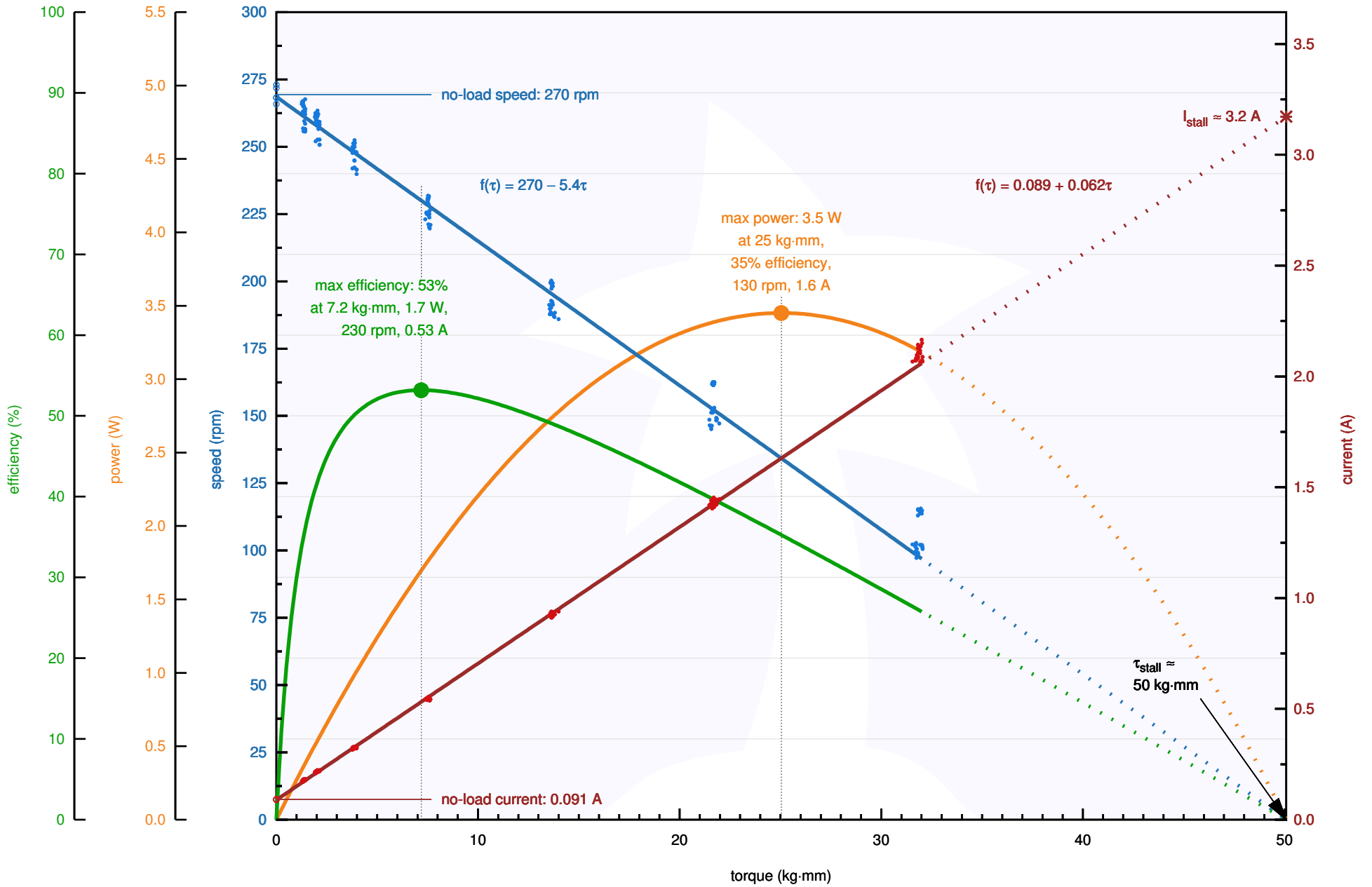

# Pololu Items #4742, #4752 (30:1 Metal Gearmotor 37D 12V) Performance at 12 V

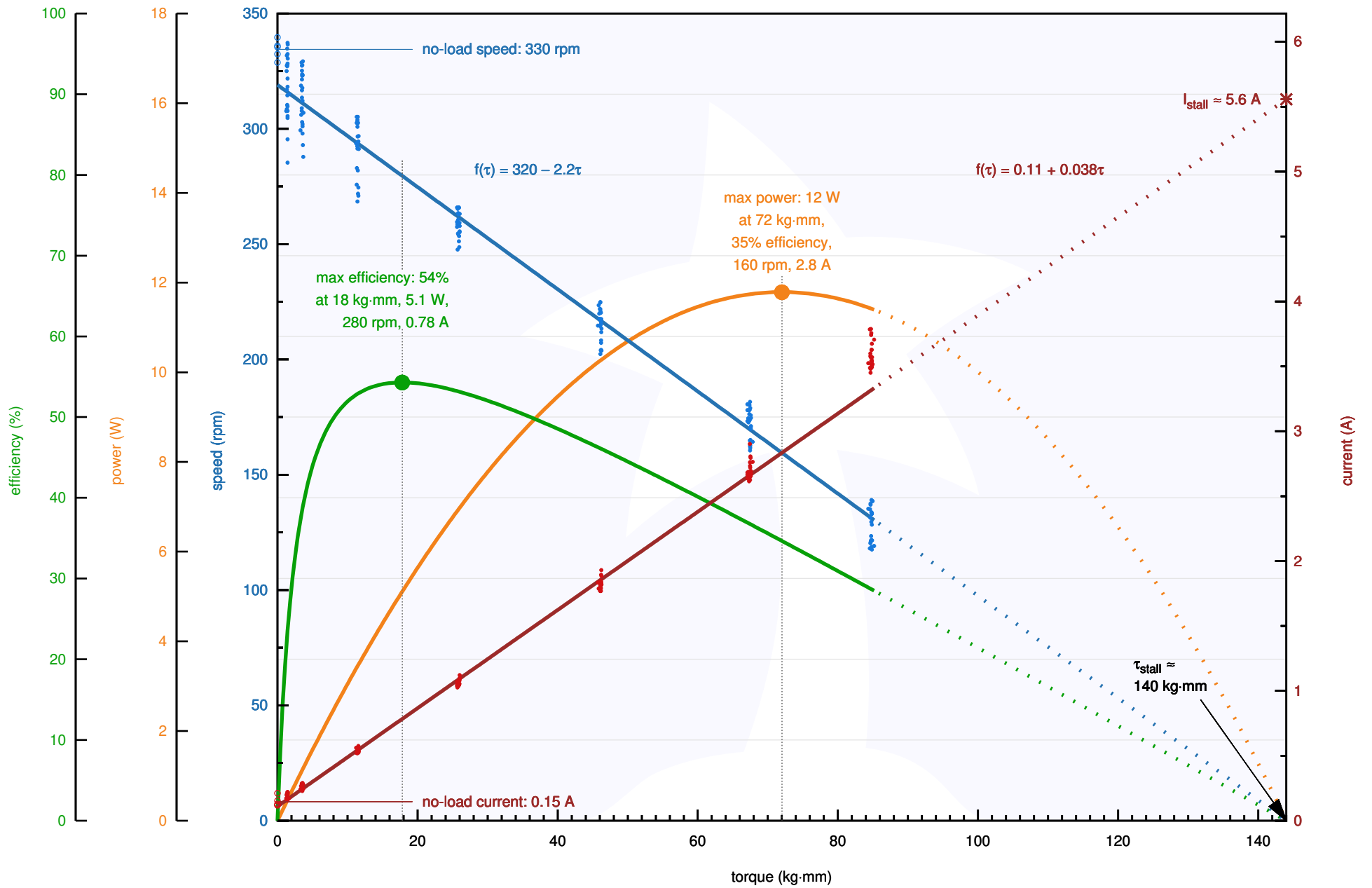

# Pololu Items #4742, #4752 (30:1 Metal Gearmotor 37D 12V) Performance at 6 V

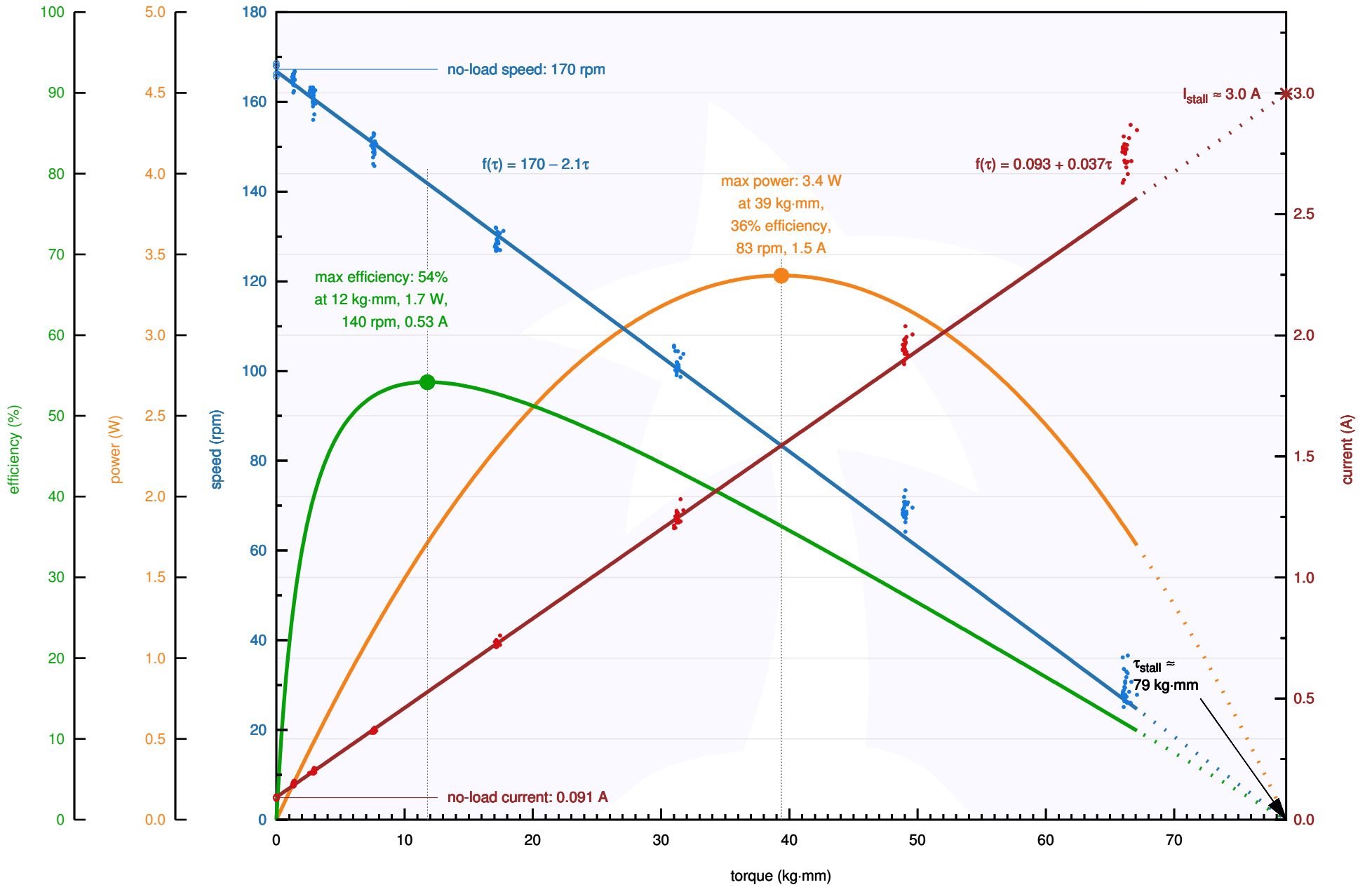

# Pololu Items #4743, #4753 (50:1 Metal Gearmotor 37D 12V) Performance at 12 V

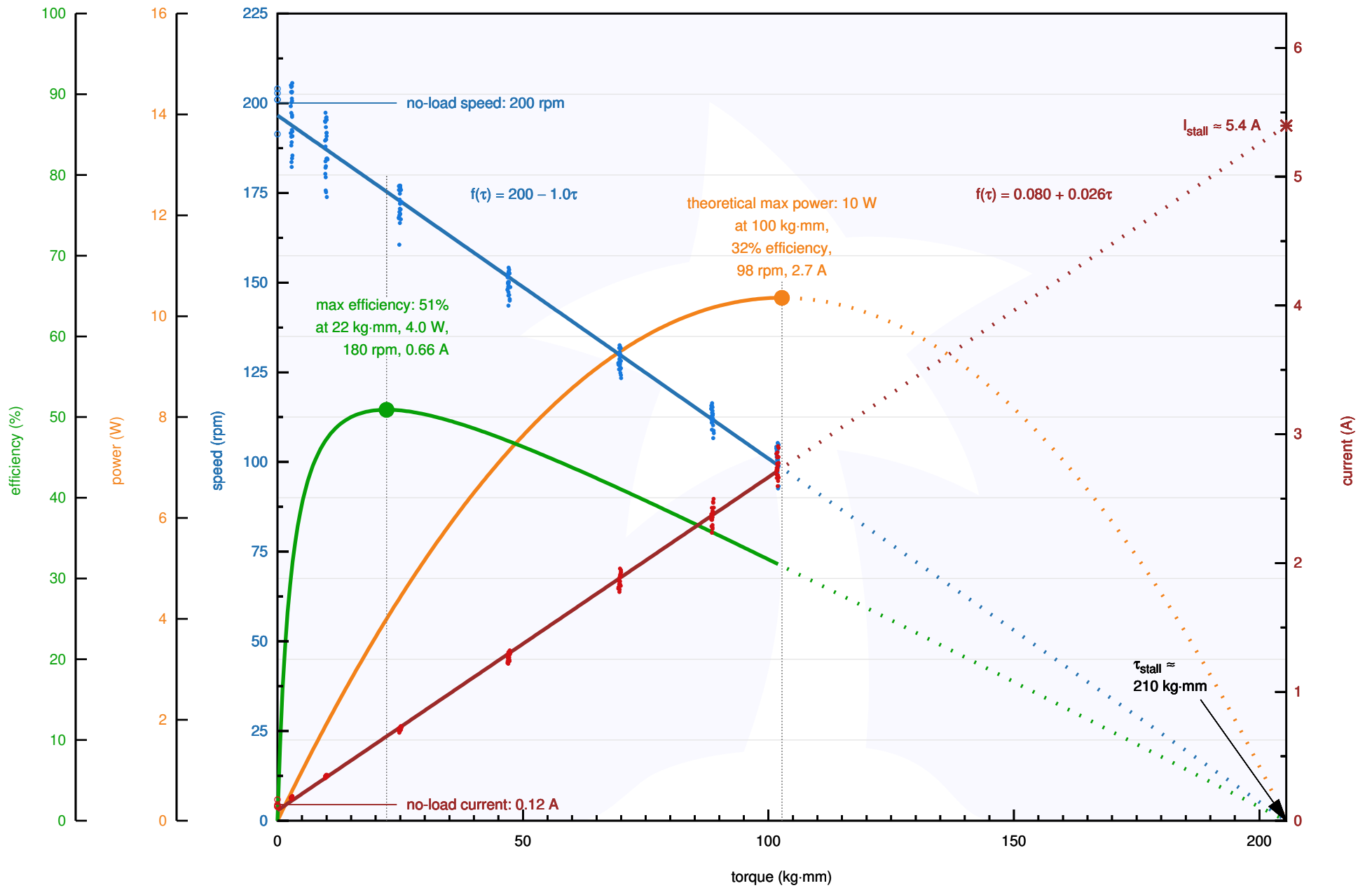

# Pololu Items #4743, #4753 (50:1 Metal Gearmotor 37D 12V) Performance at 6 V

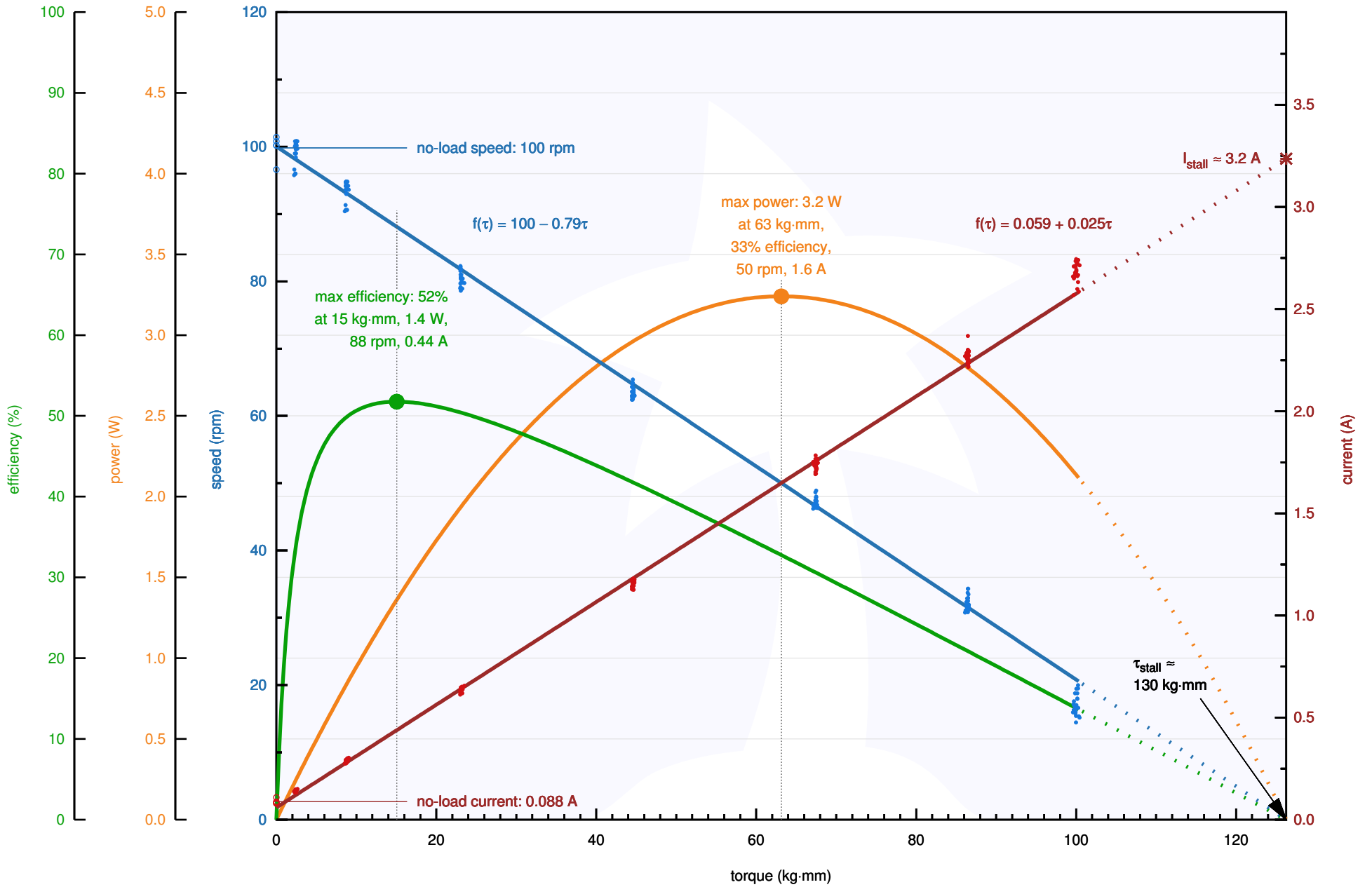

# Pololu Items #4744, #4754 (70:1 Metal Gearmotor 37D 12V) Performance at 12 V

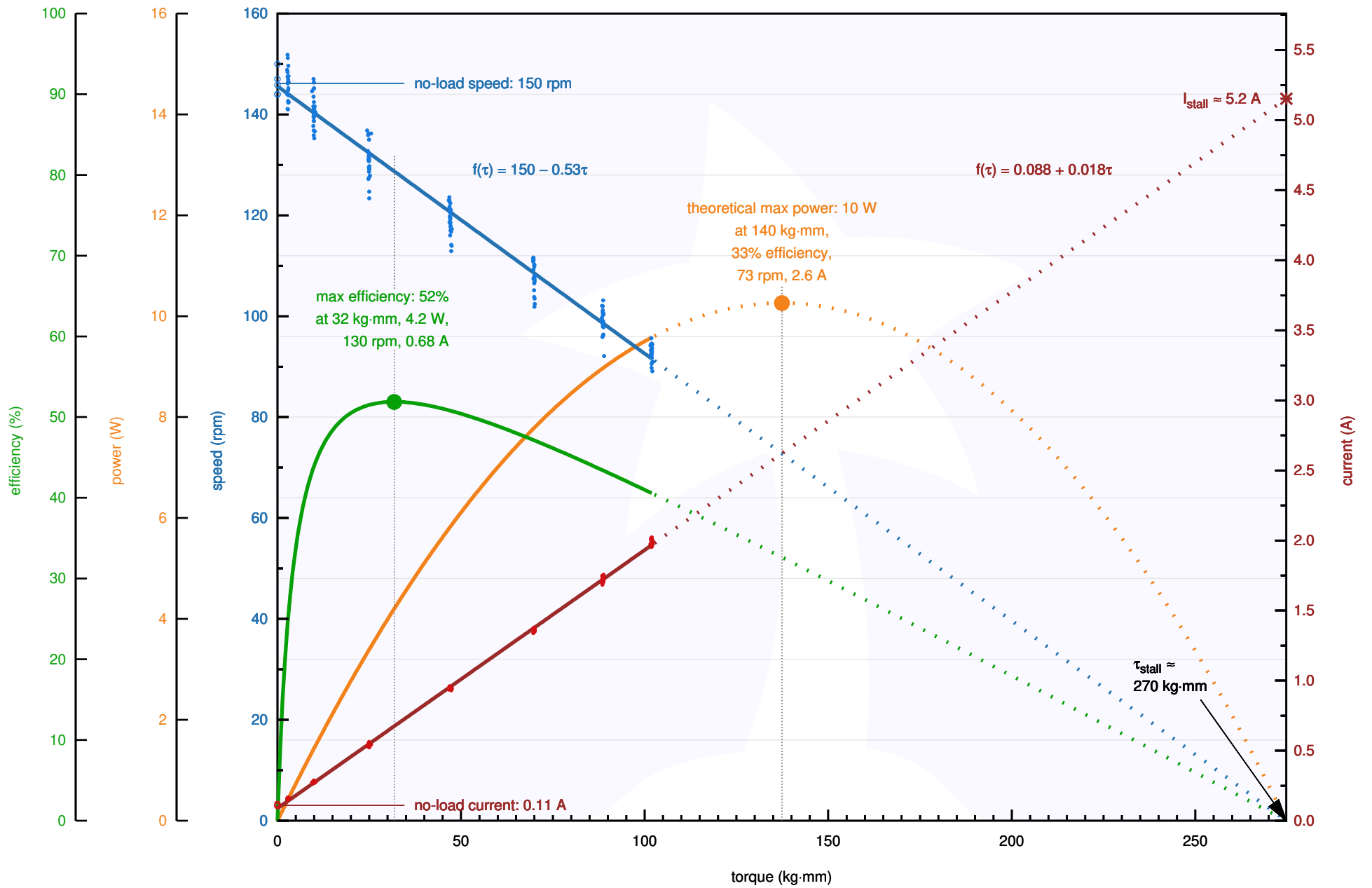

# Pololu Items #4744, #4754 (70:1 Metal Gearmotor 37D 12V) Performance at 6 V

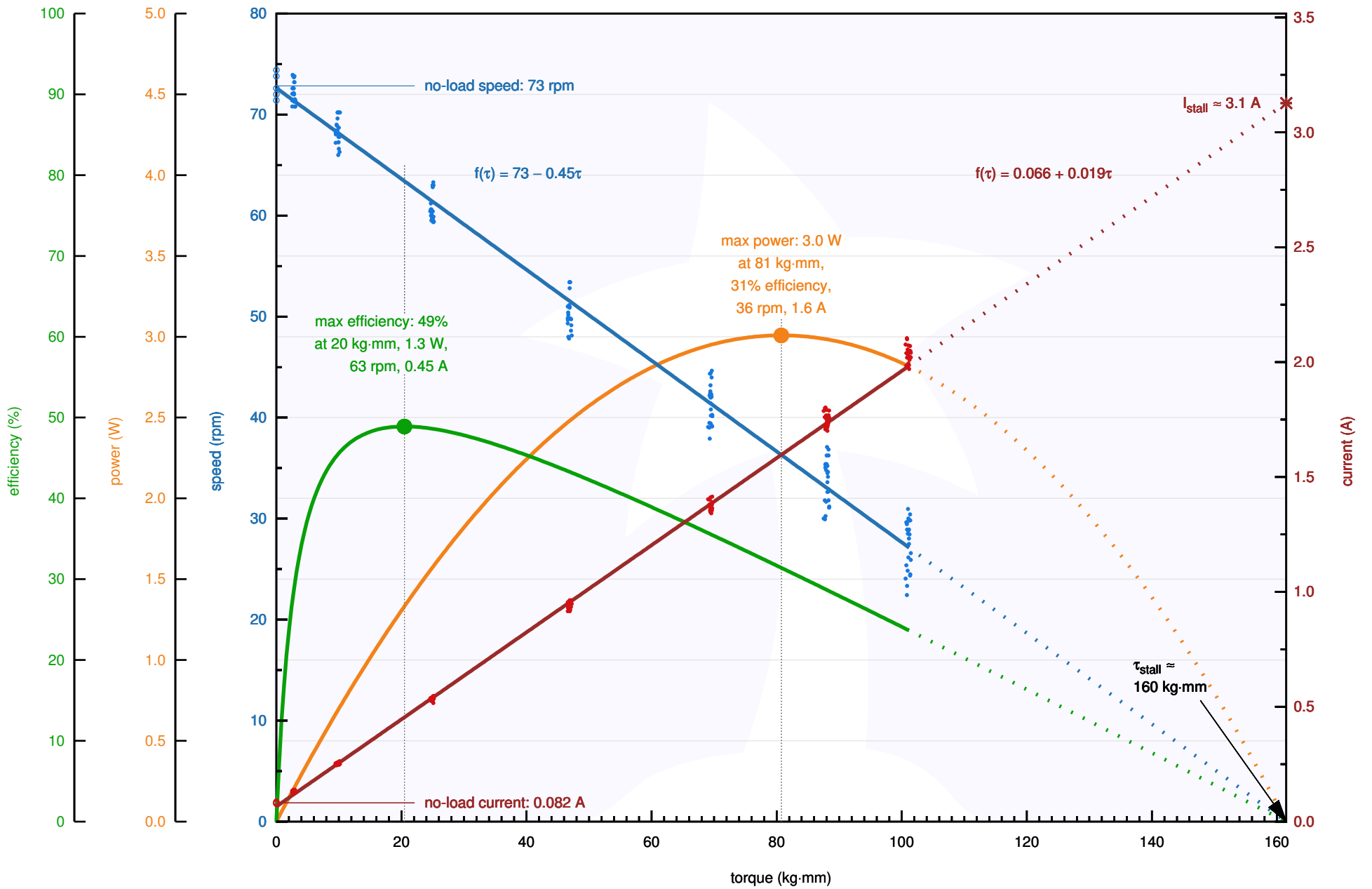



# Pololu Items #4745, #4755 (100:1 Metal Gearmotor 37D 12V) Performance at 12 V

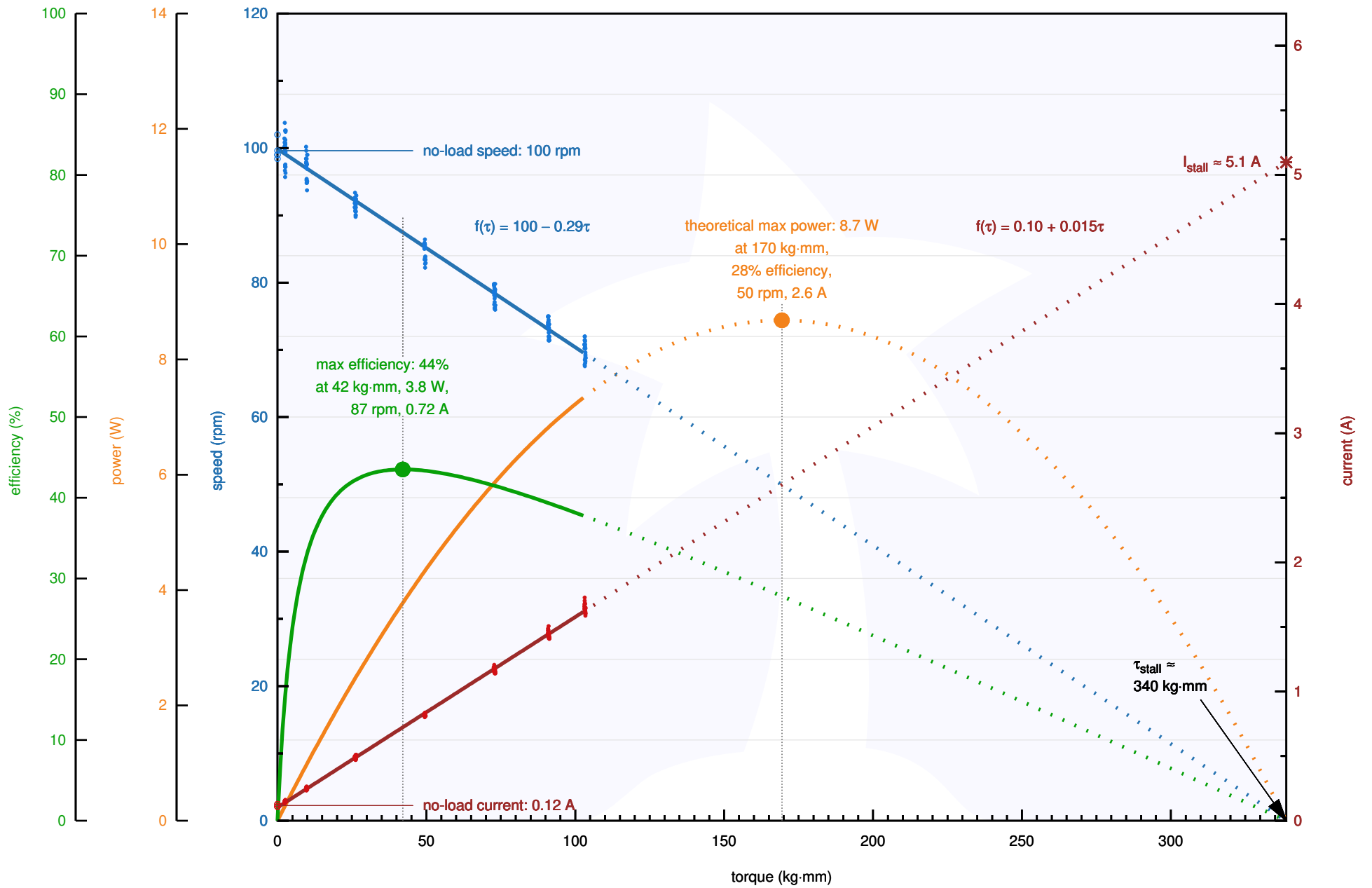

# Pololu Items #4745, #4755 (100:1 Metal Gearmotor 37D 12V) Performance at 6 V

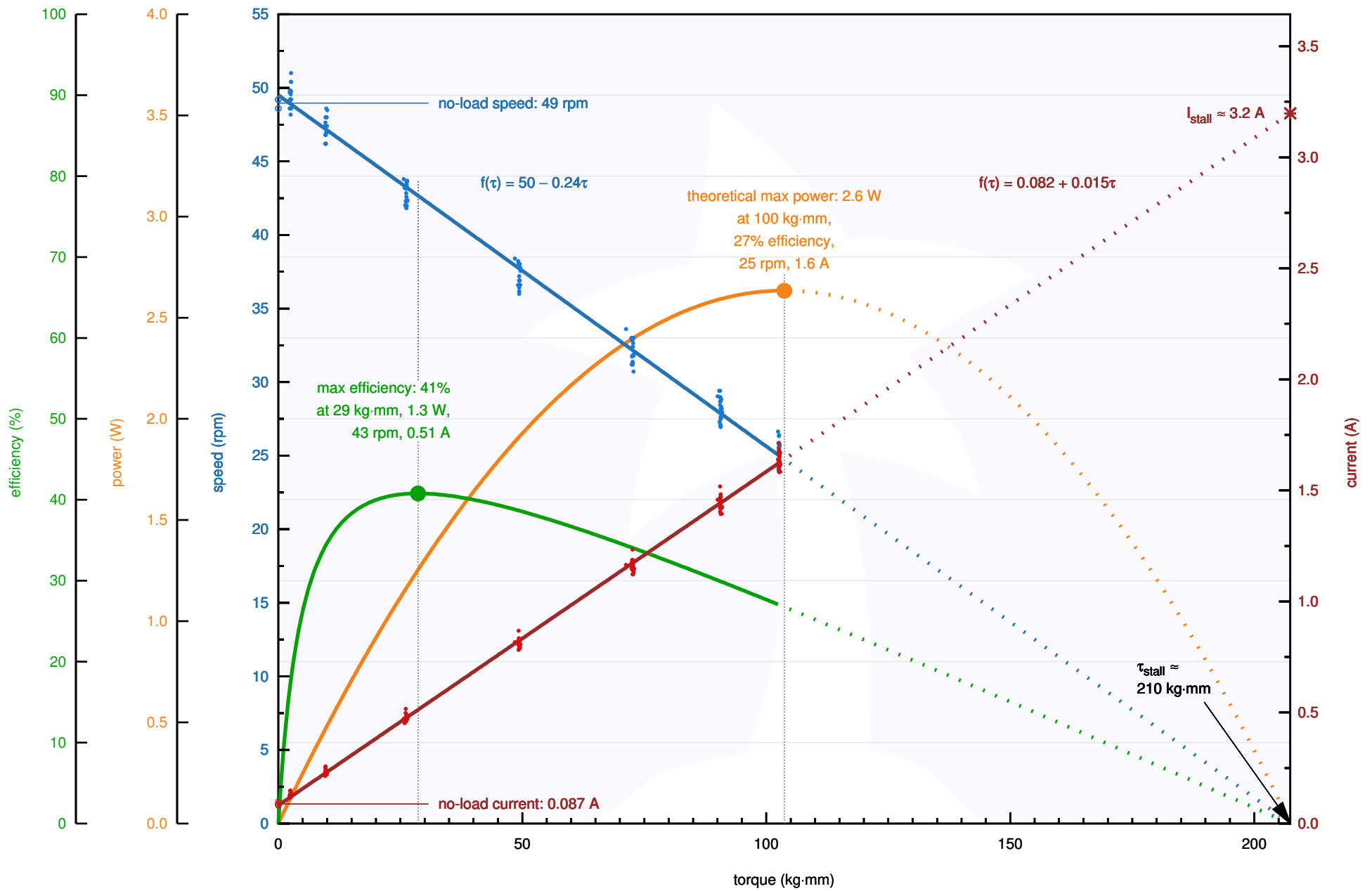

# Pololu Items #4746, #4756 (131:1 Metal Gearmotor 37D 12V) Performance at 12 V

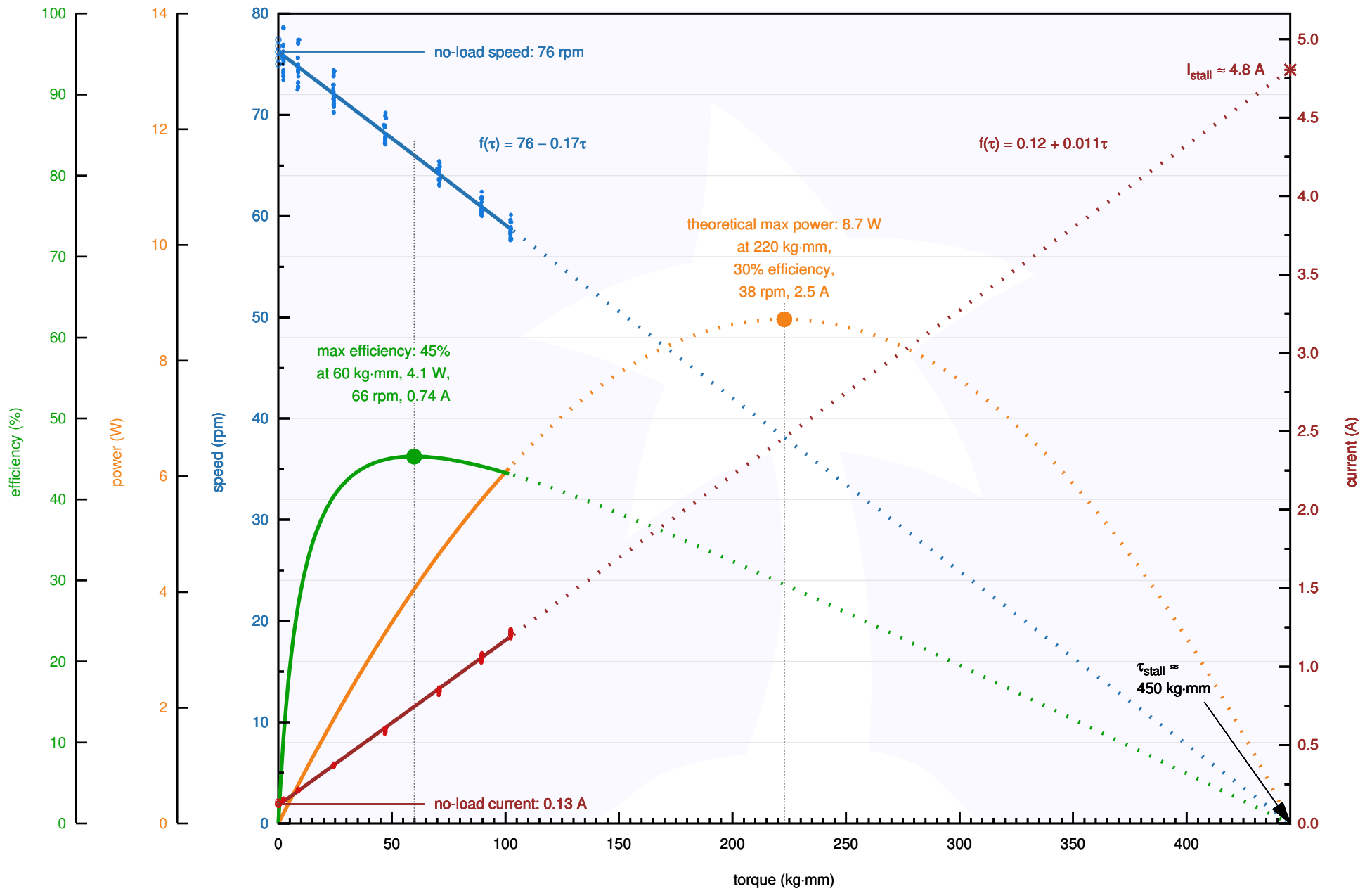

# Pololu Items #4746, #4756 (131:1 Metal Gearmotor 37D 12V) Performance at 6 V

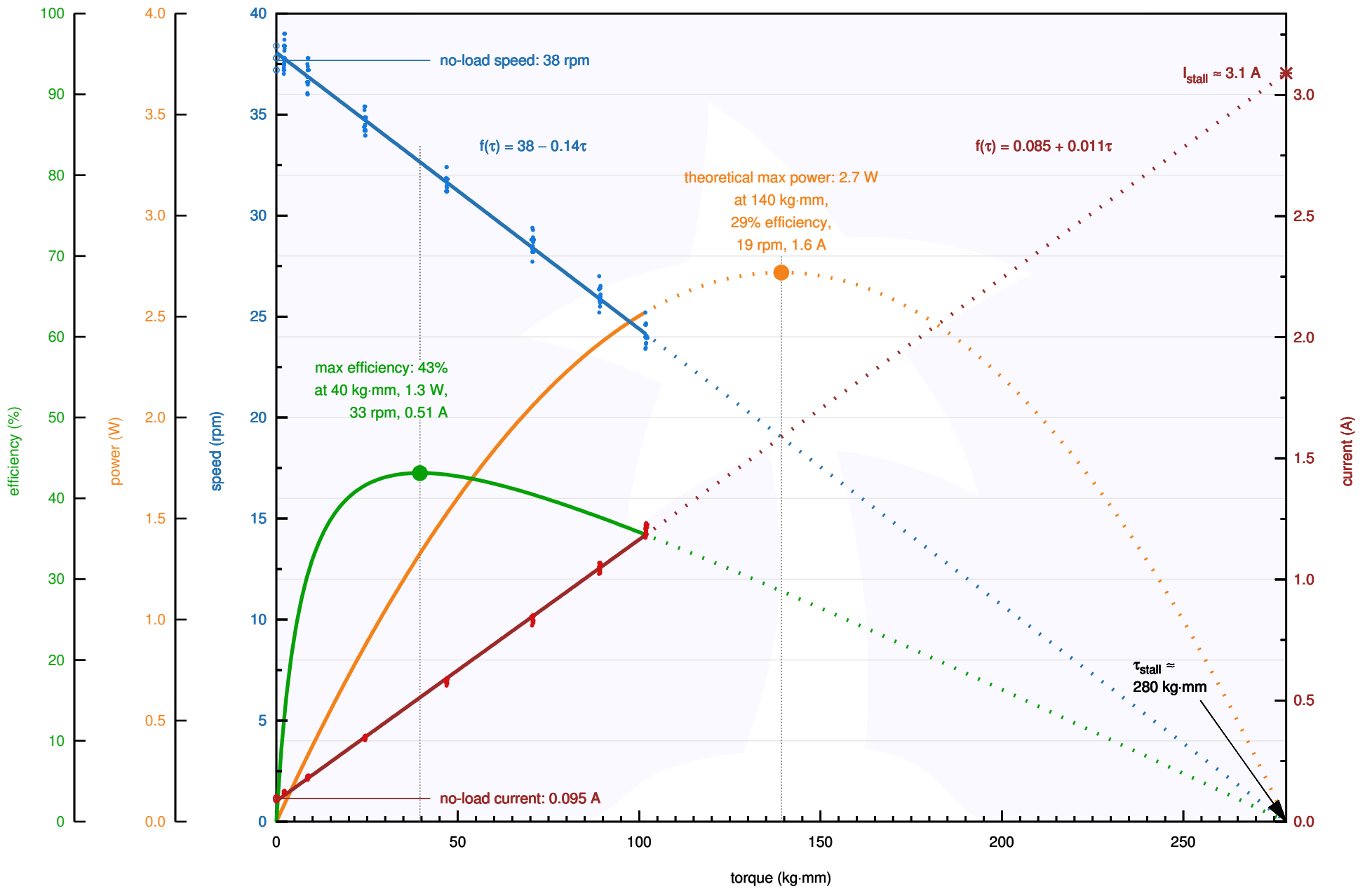

# Pololu Items #2828, #2829 (150:1 Metal Gearmotor 37D 12V) Performance at 12 V

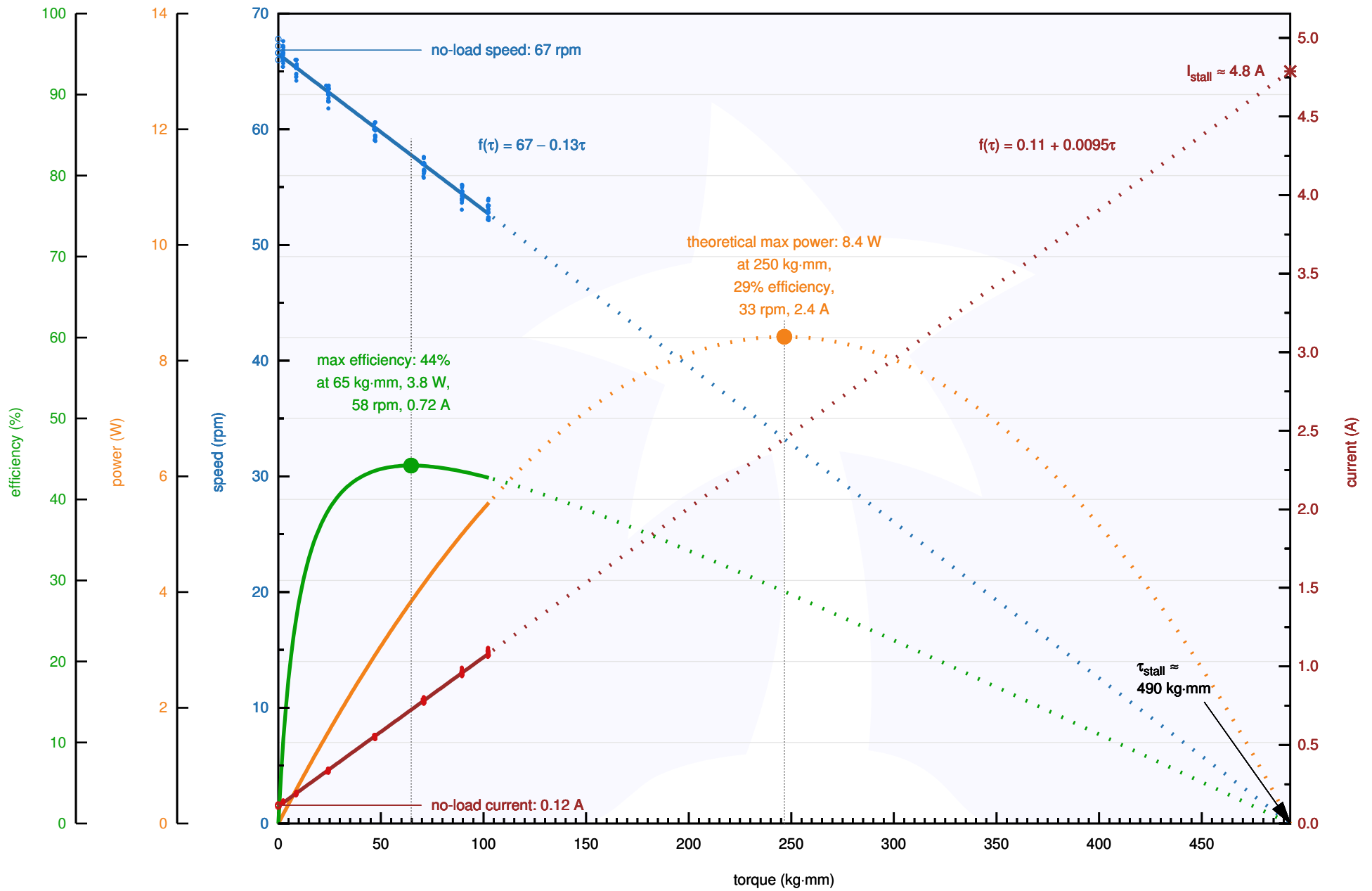

# Pololu Items #2828, #2829 (150:1 Metal Gearmotor 37D 12V) Performance at 6 V

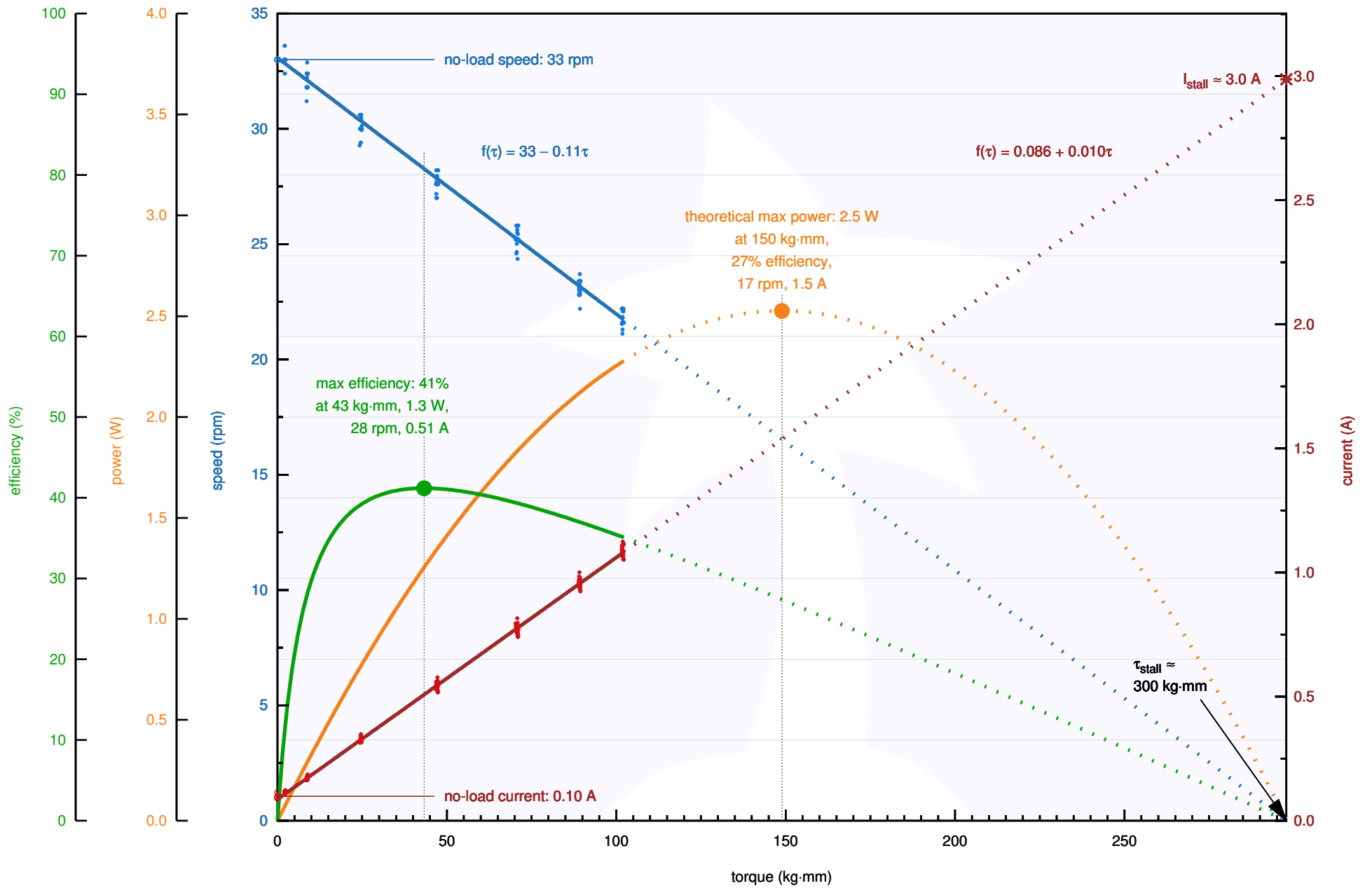

# Pololu Items #4688, #4698 (6.3:1 Metal Gearmotor 37D 24V) Performance at 24 V

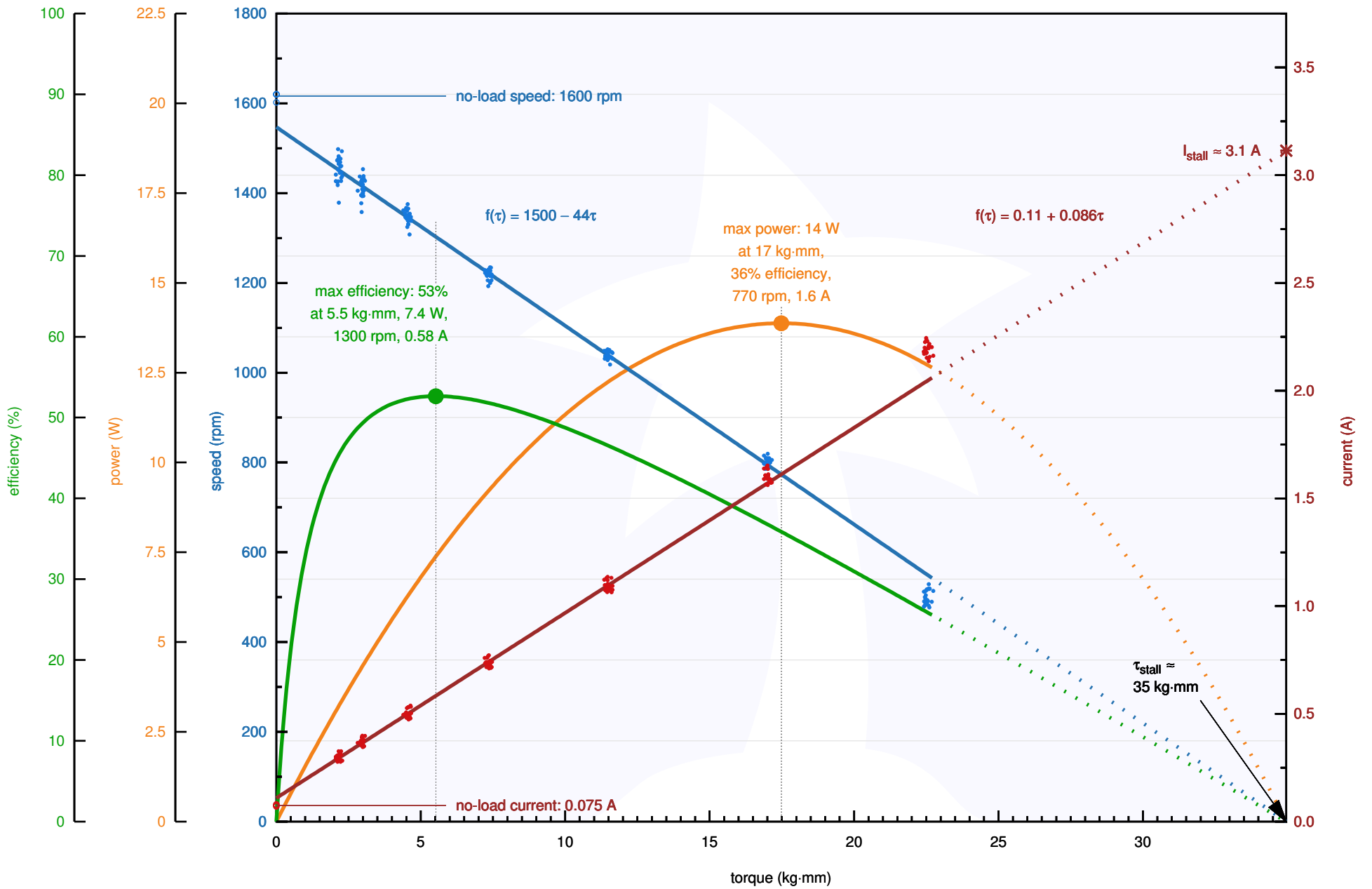

# Pololu Items #4688, #4698 (6.3:1 Metal Gearmotor 37D 24V) Performance at 12 V

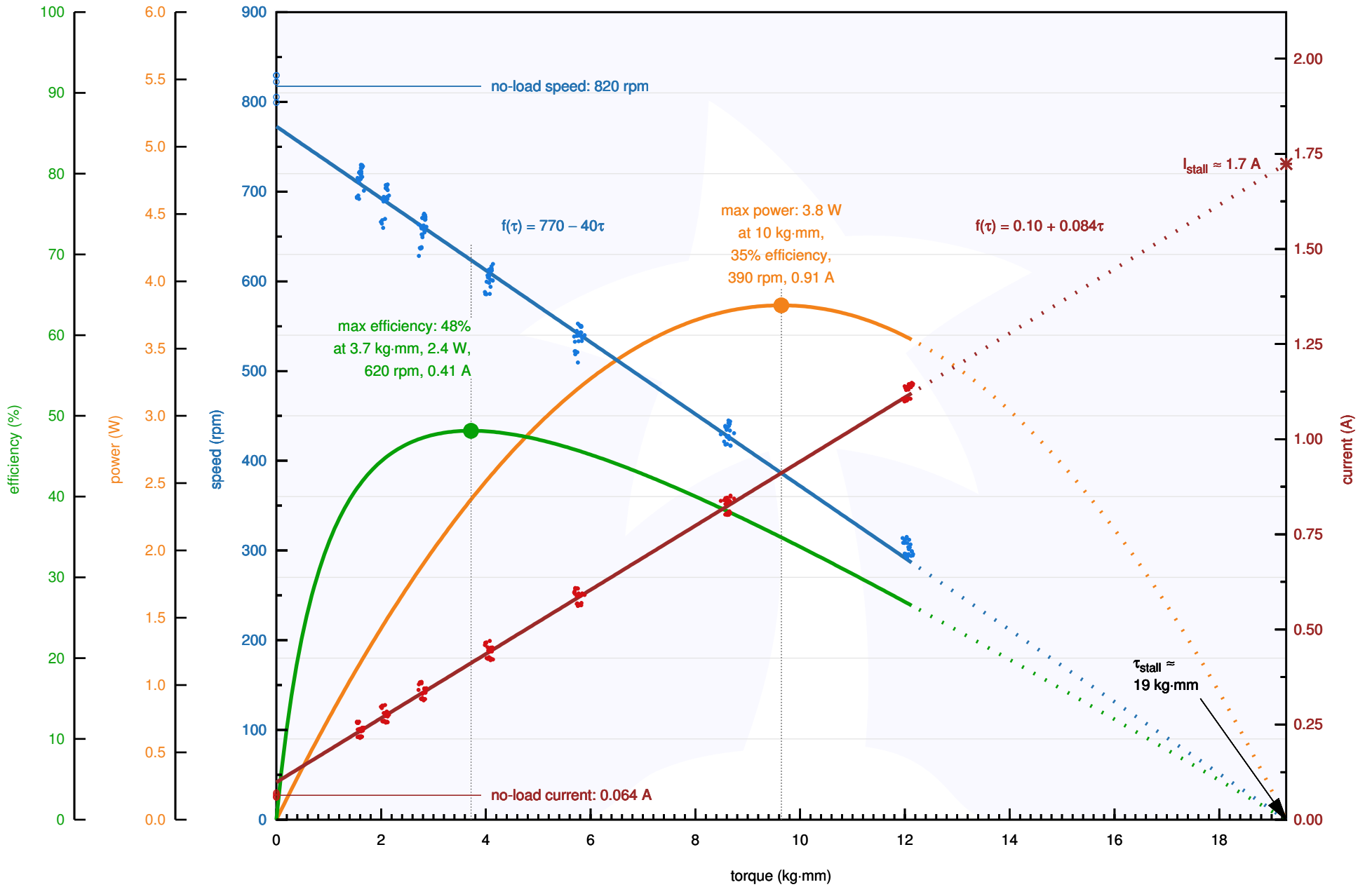



# Pololu Items #4689, #4699 (10:1 Metal Gearmotor 37D 24V) Performance at 24 V

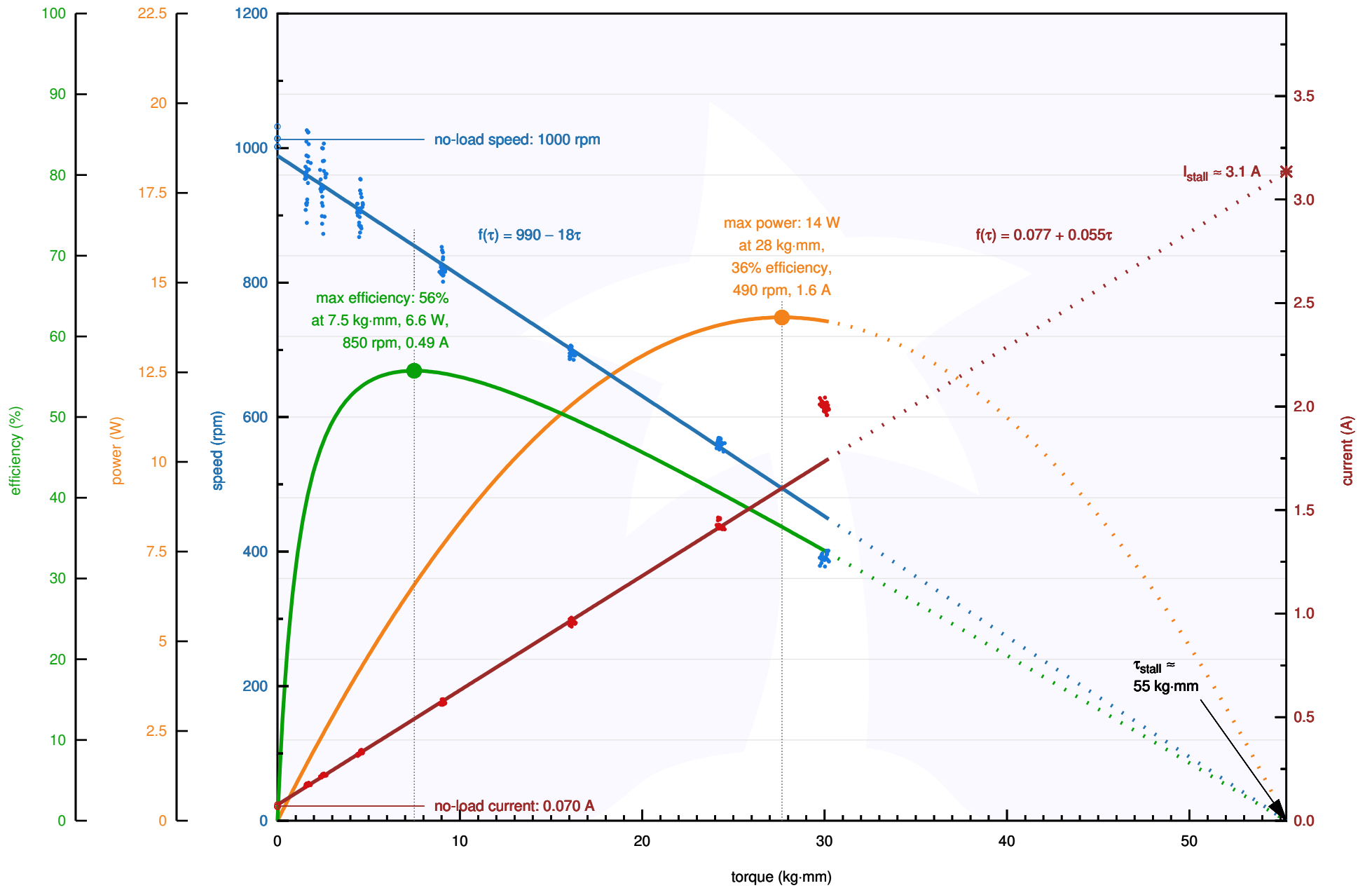

# Pololu Items #4689, #4699 (10:1 Metal Gearmotor 37D 24V) Performance at 12 V

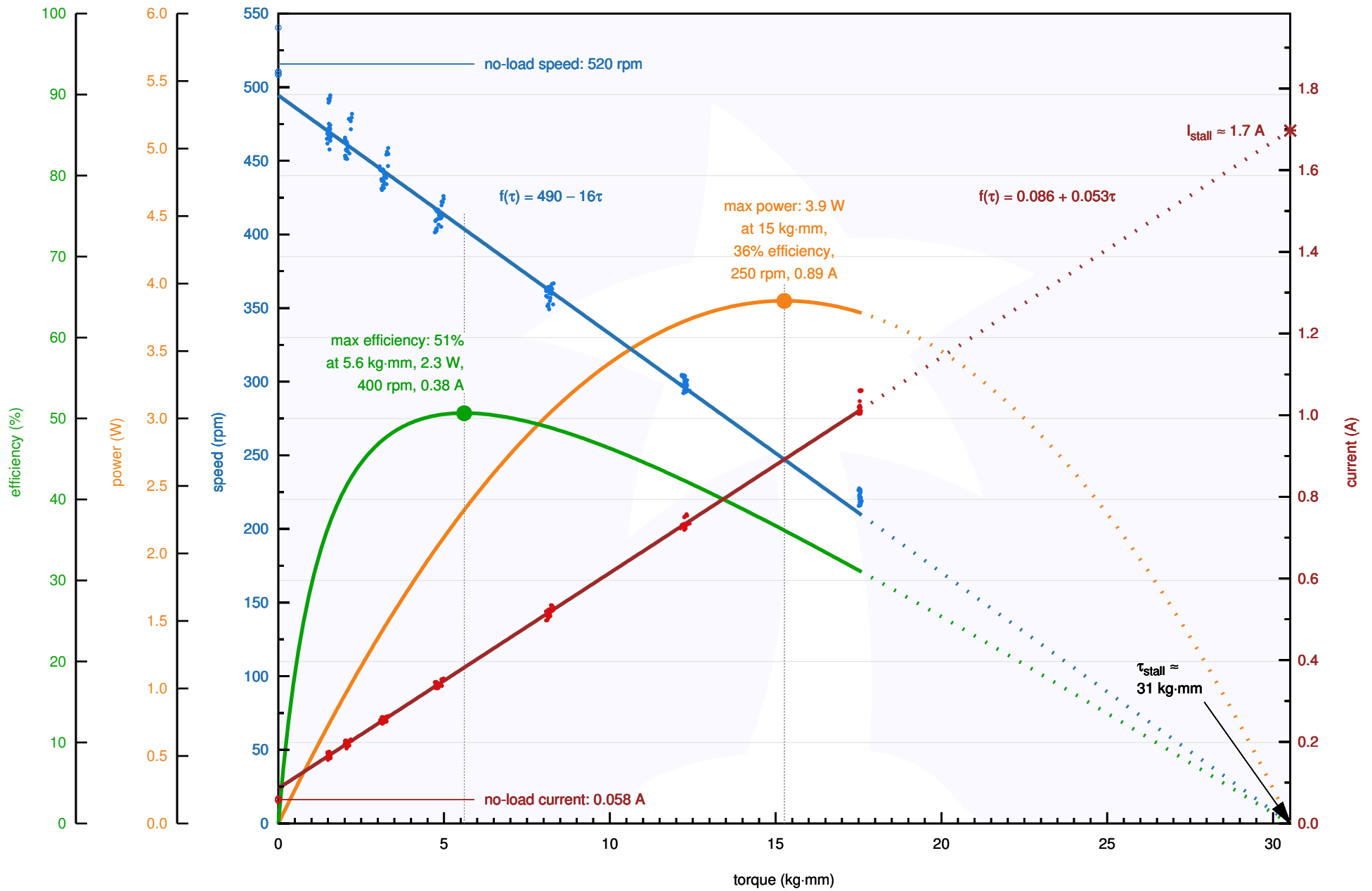

# Pololu Items #4681, #4691 (19:1 Metal Gearmotor 37D 24V) Performance at 24 V

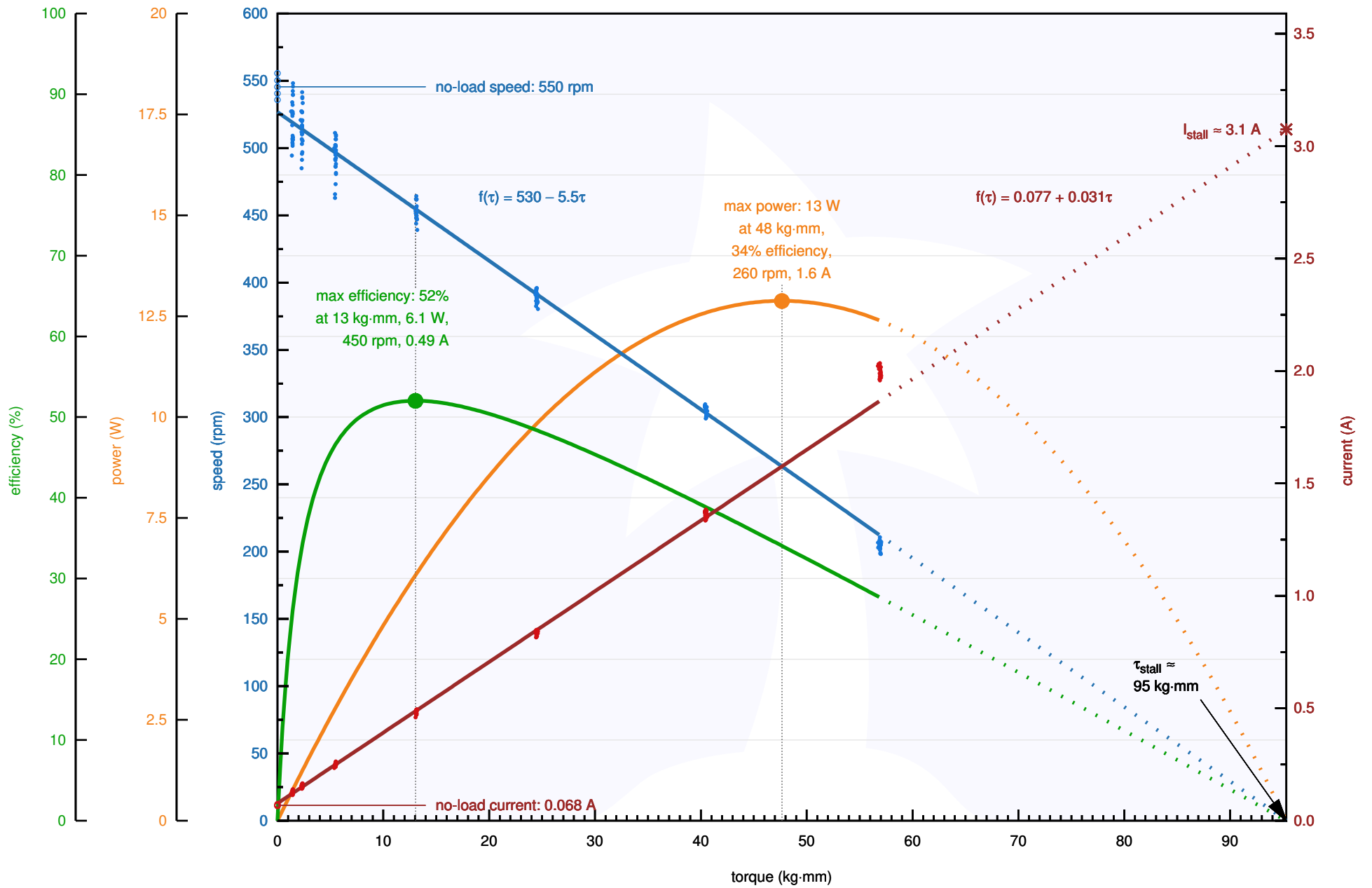

# Pololu Items #4681, #4691 (19:1 Metal Gearmotor 37D 24V) Performance at 12 V

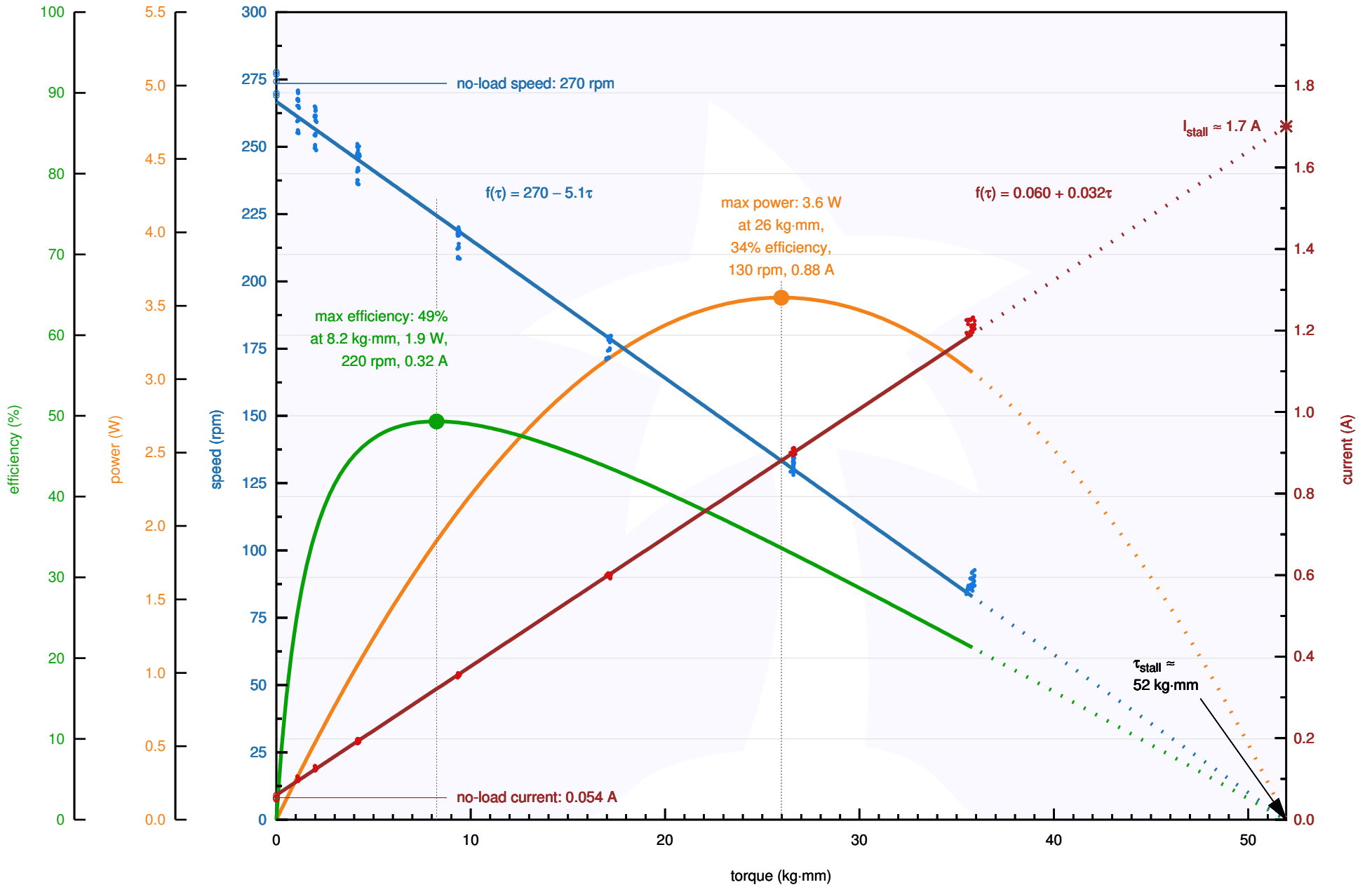

# Pololu Items #4682, #4692 (30:1 Metal Gearmotor 37D 24V) Performance at 24 V

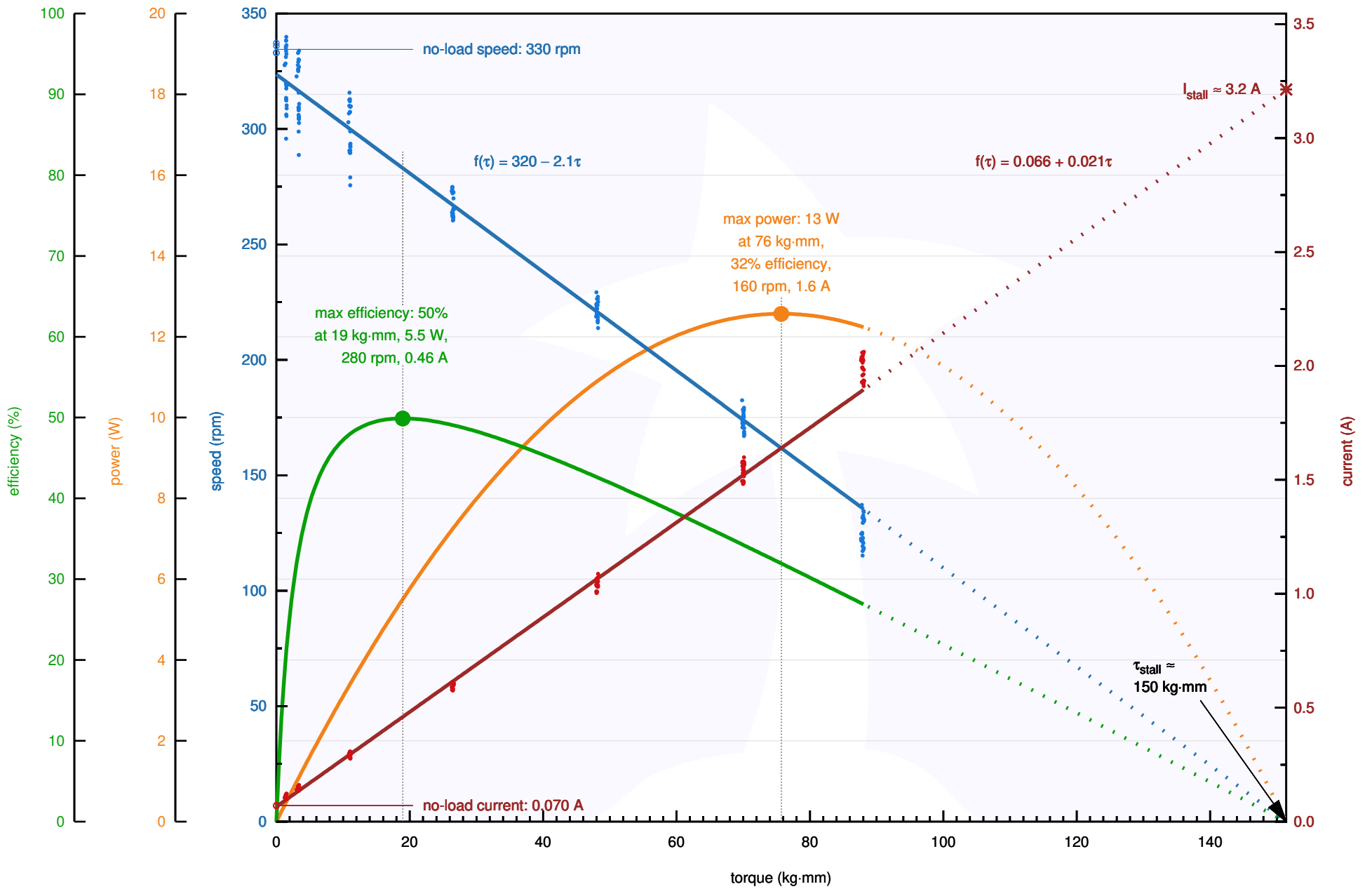

# Pololu Items #4682, #4692 (30:1 Metal Gearmotor 37D 24V) Performance at 12 V

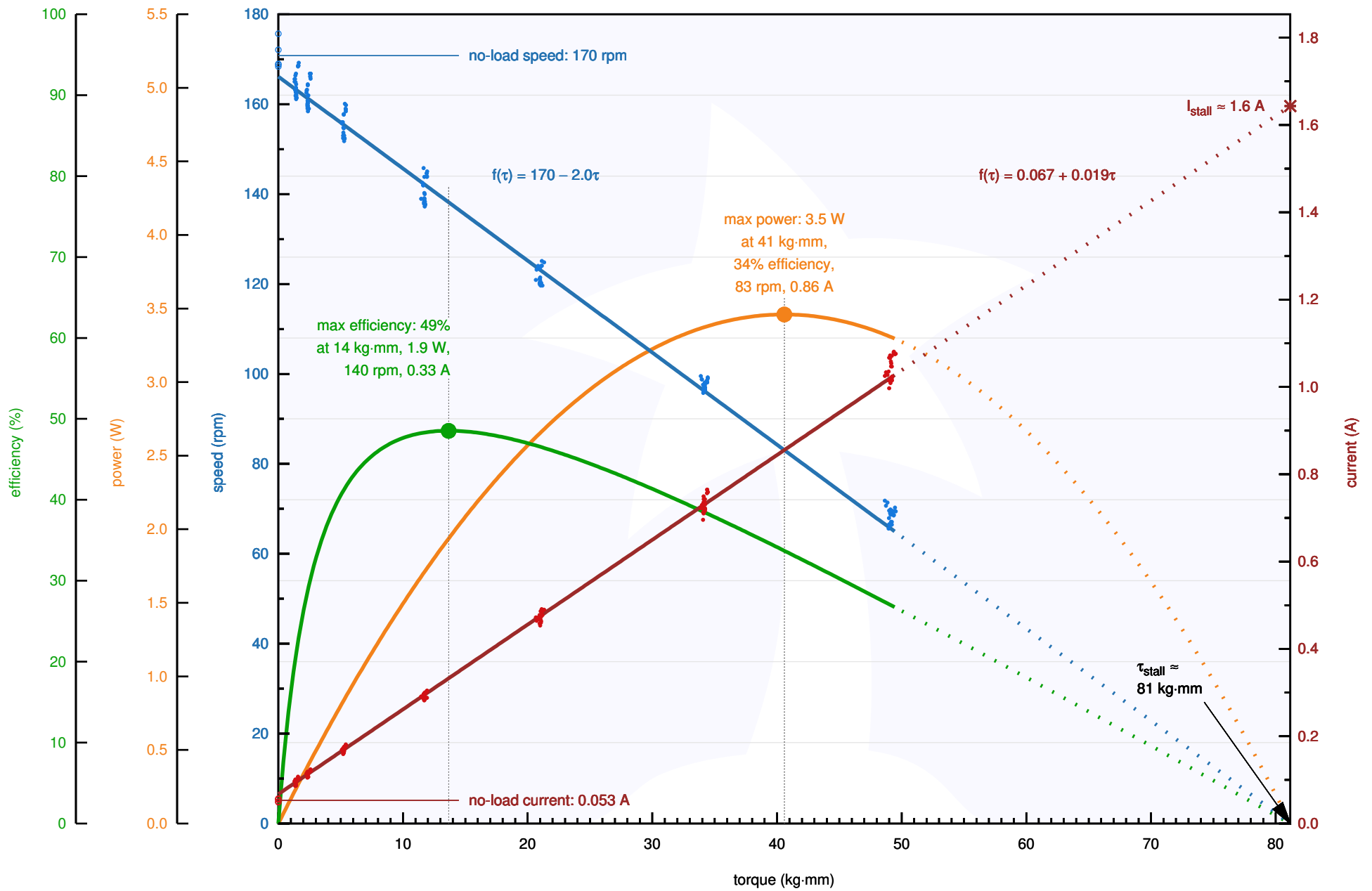

# Pololu Items #4683, #4693 (50:1 Metal Gearmotor 37D 24V) Performance at 24 V

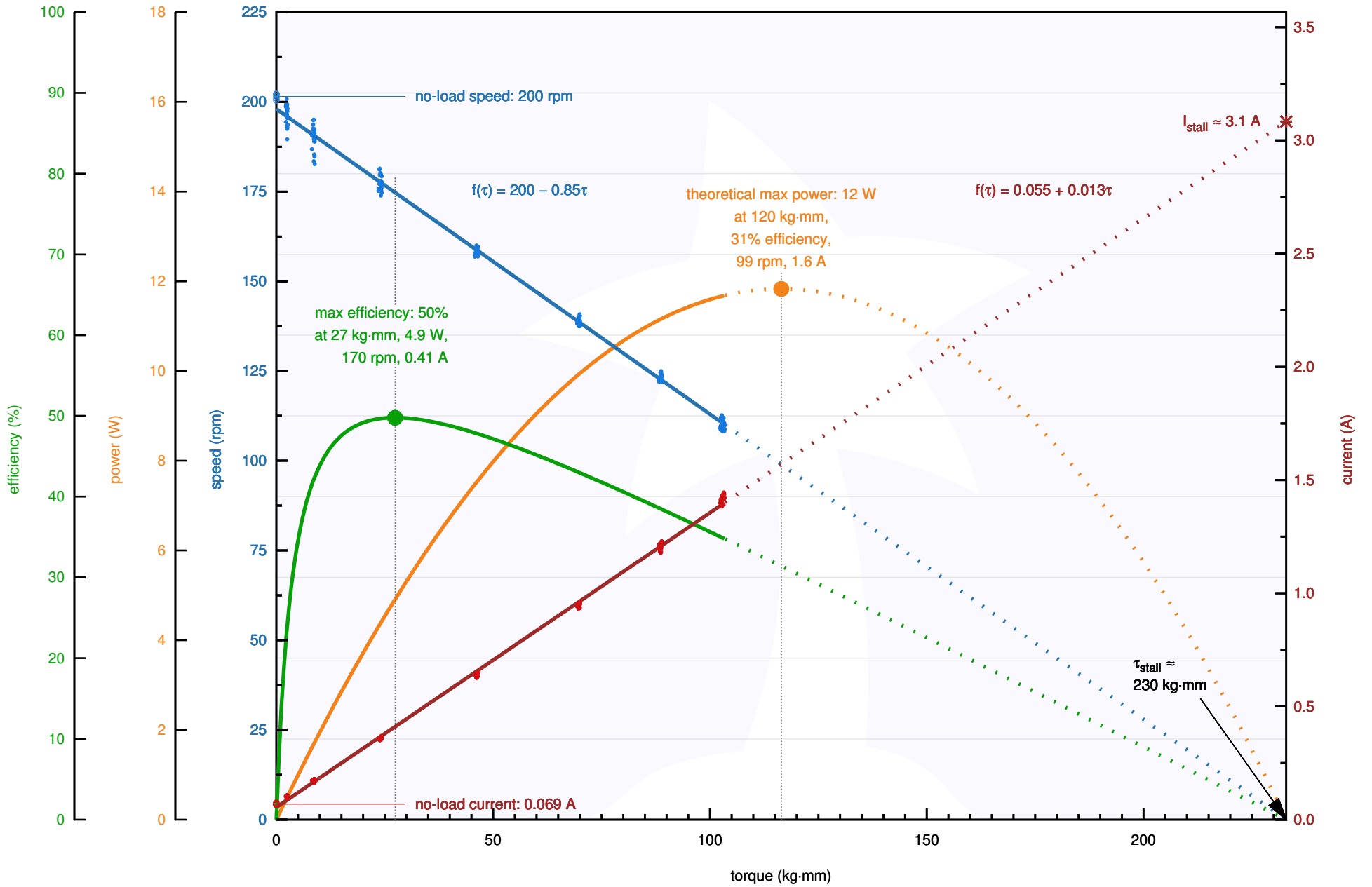

# Pololu Items #4683, #4693 (50:1 Metal Gearmotor 37D 24V) Performance at 12 V

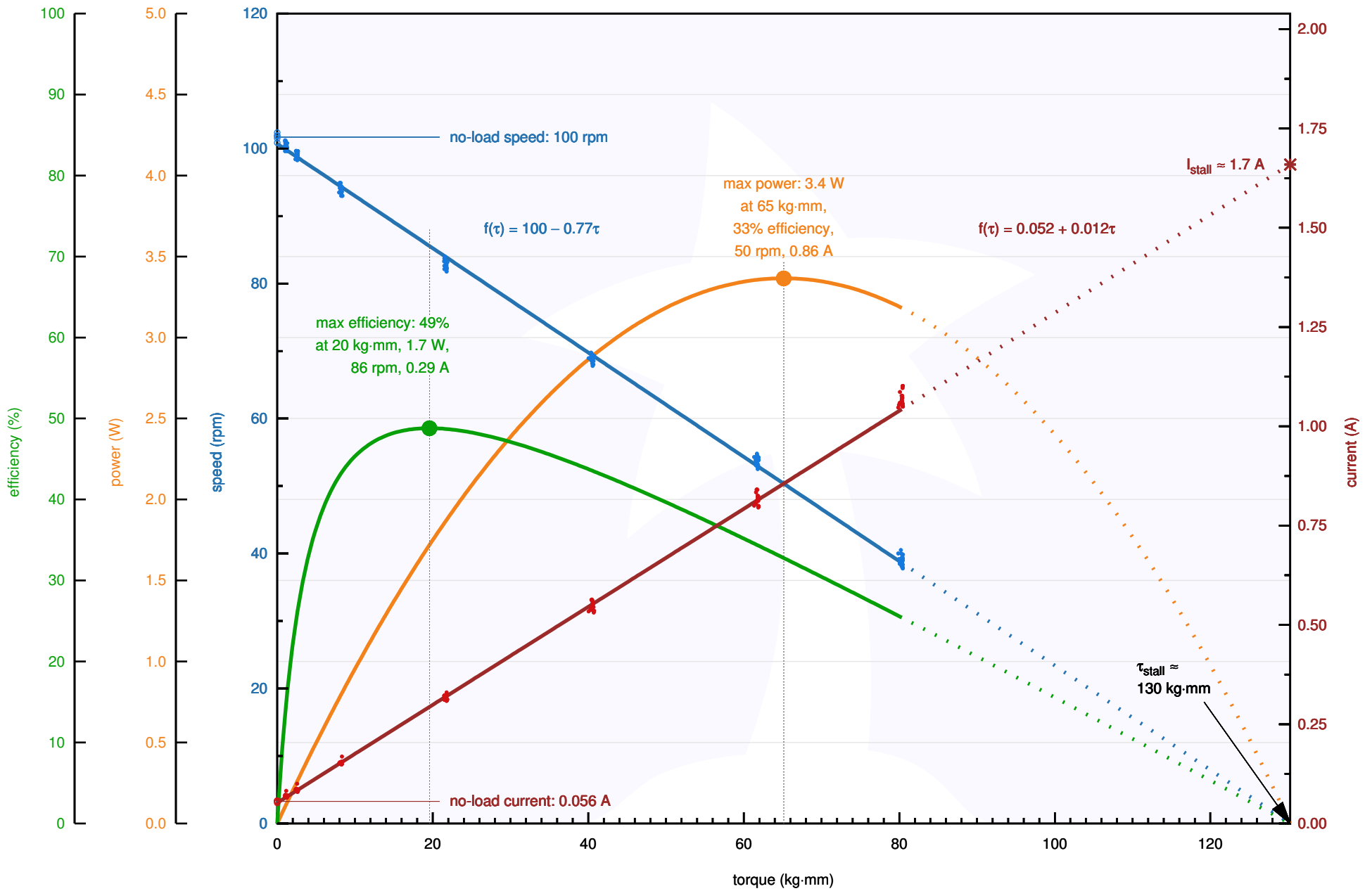



# Pololu Items #4684, #4694 (70:1 Metal Gearmotor 37D 24V) Performance at 24 V

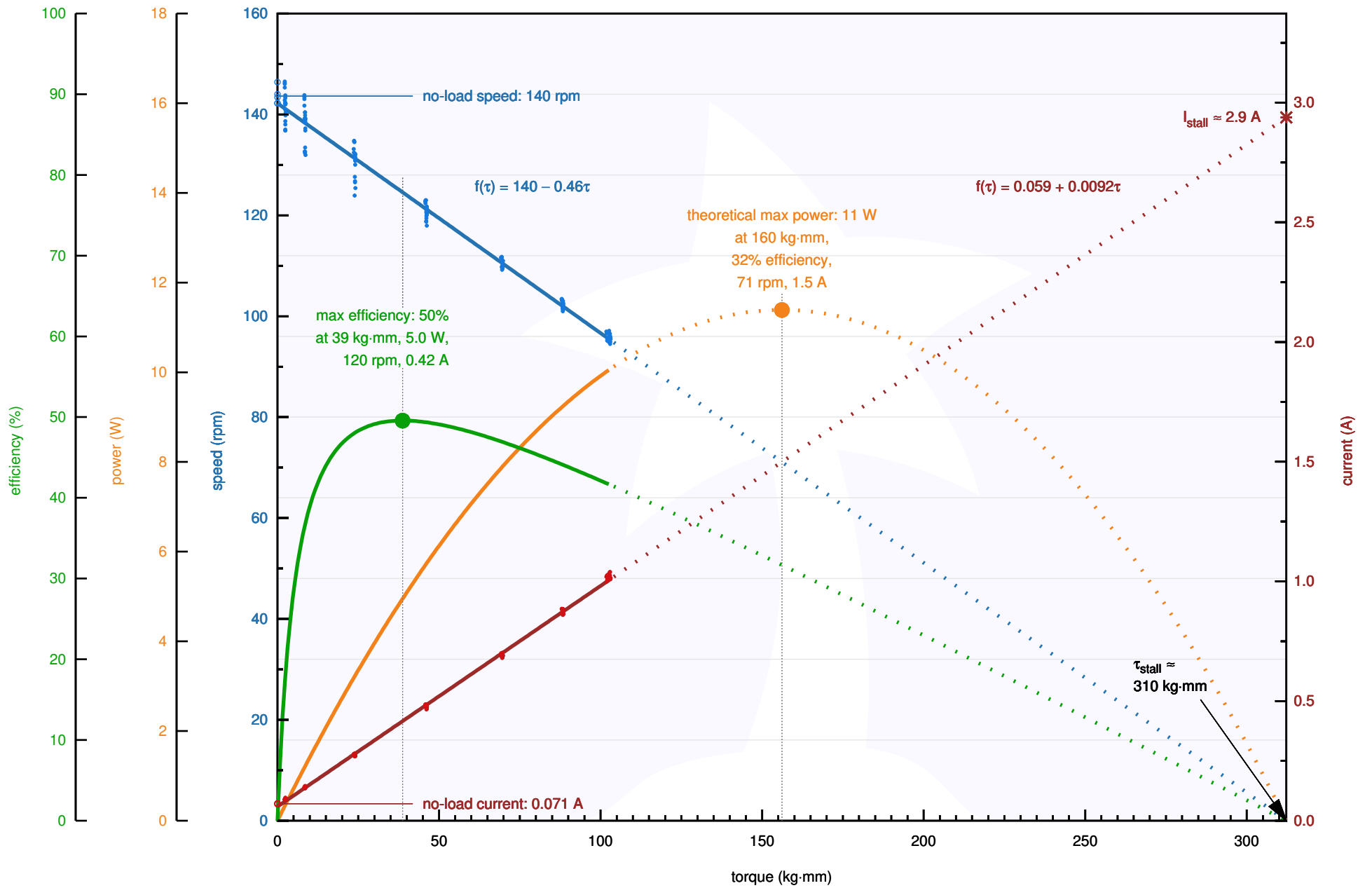

# Pololu Items #4684, #4694 (70:1 Metal Gearmotor 37D 24V) Performance at 12 V

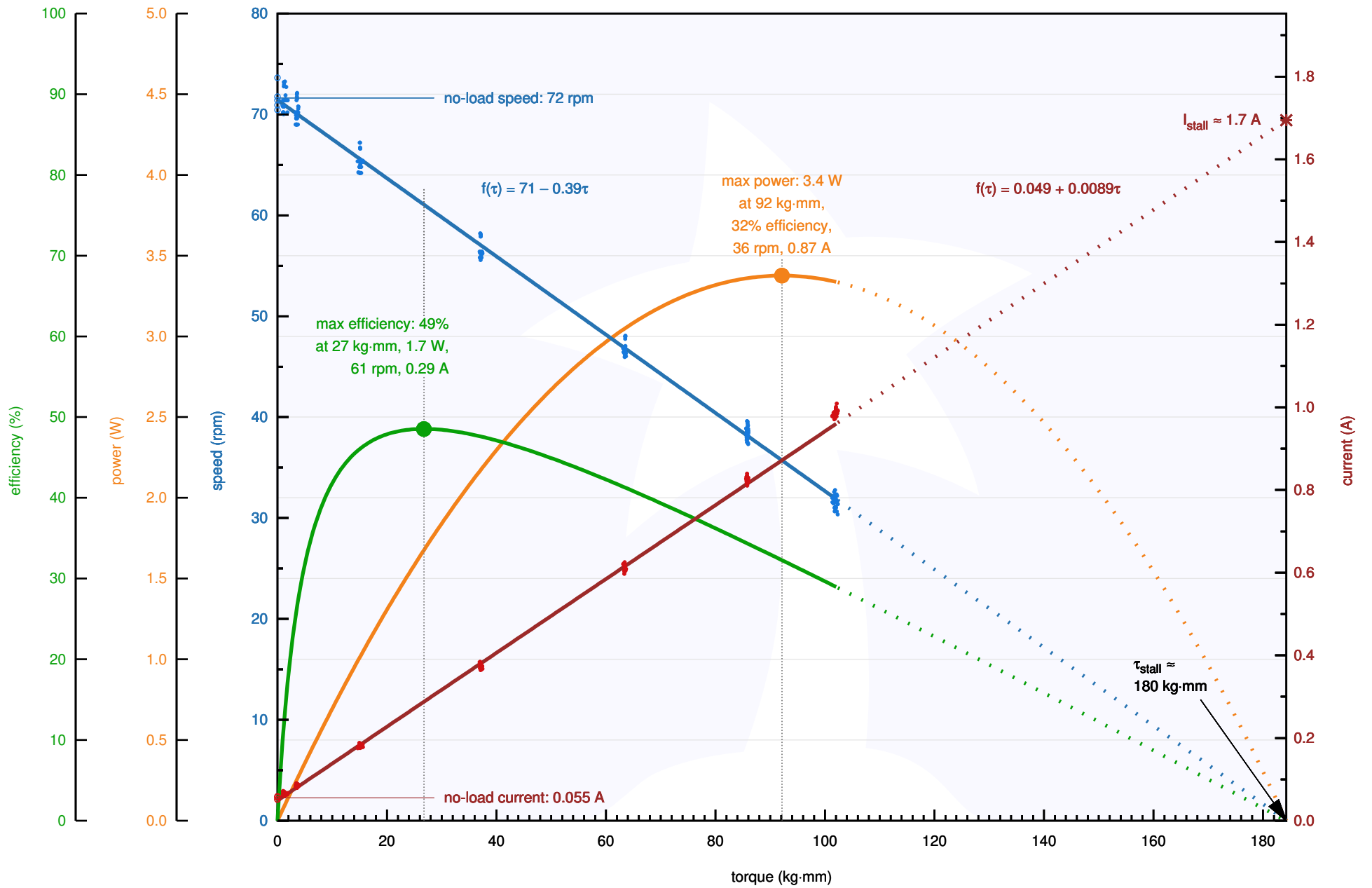

# Pololu Items #4685, #4695 (100:1 Metal Gearmotor 37D 24V) Performance at 24 V

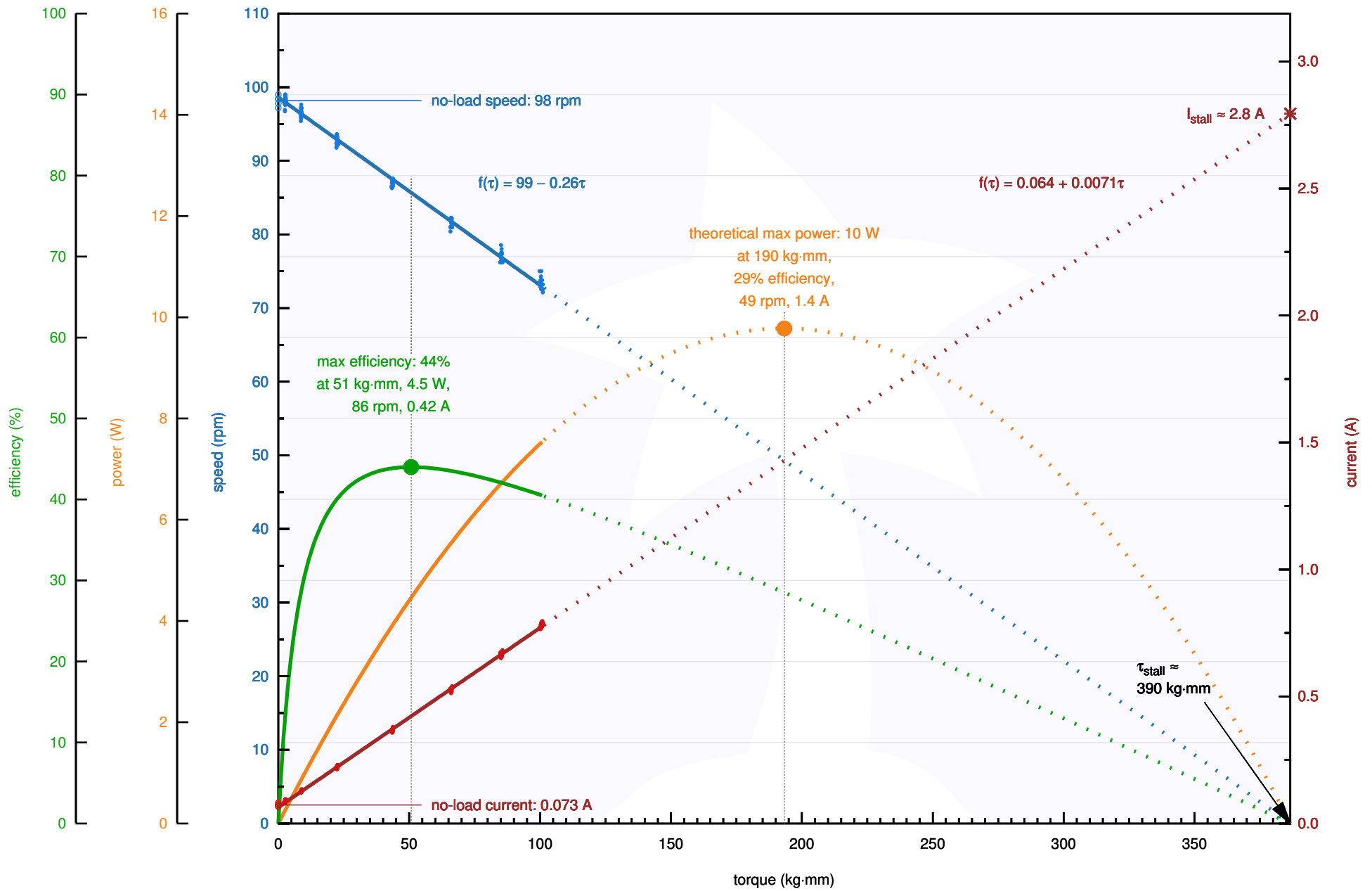

# Pololu Items #4685, #4695 (100:1 Metal Gearmotor 37D 24V) Performance at 12 V

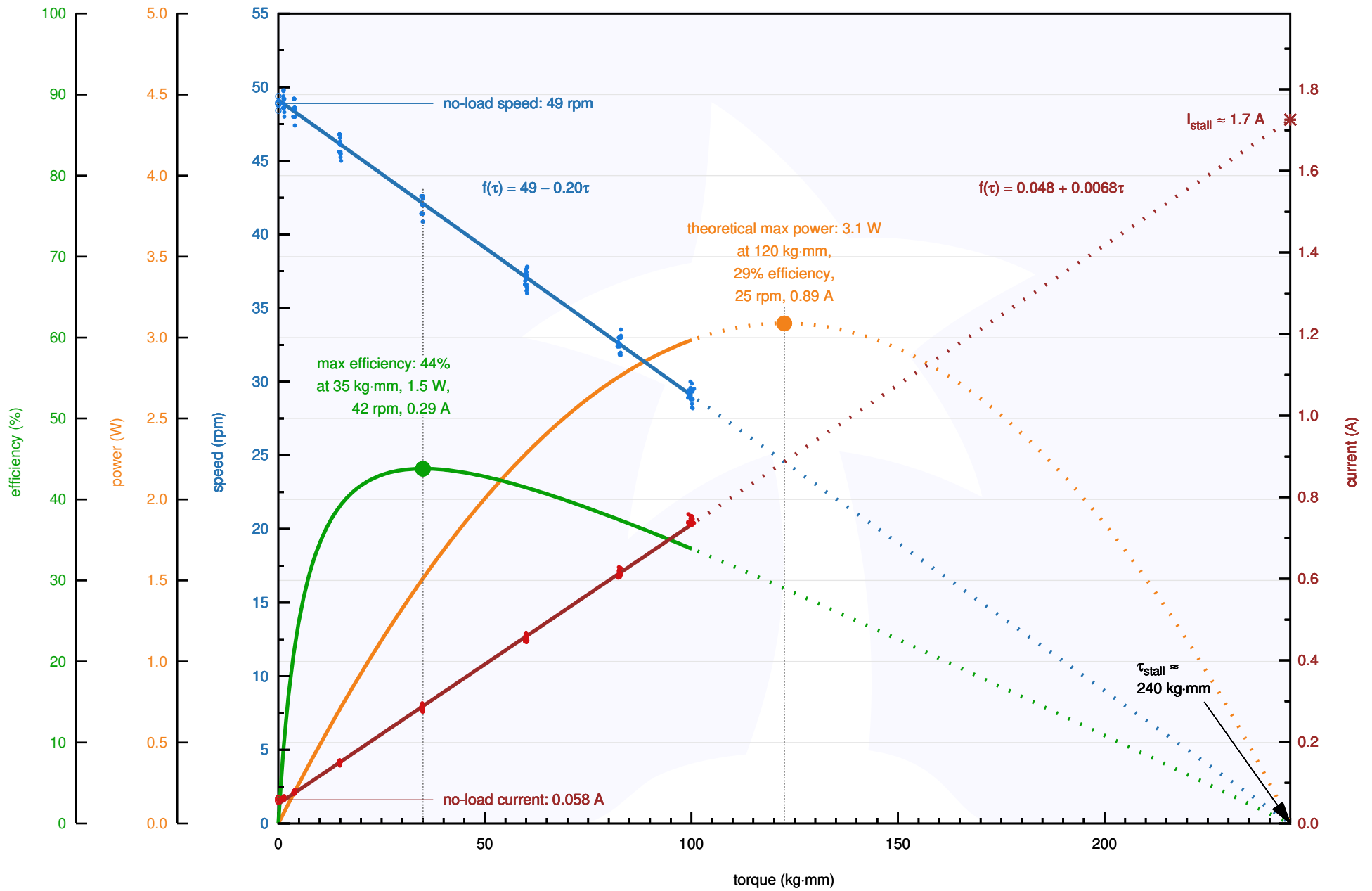

# Pololu Items #4686, #4696 (131:1 Metal Gearmotor 37D 24V) Performance at 24 V

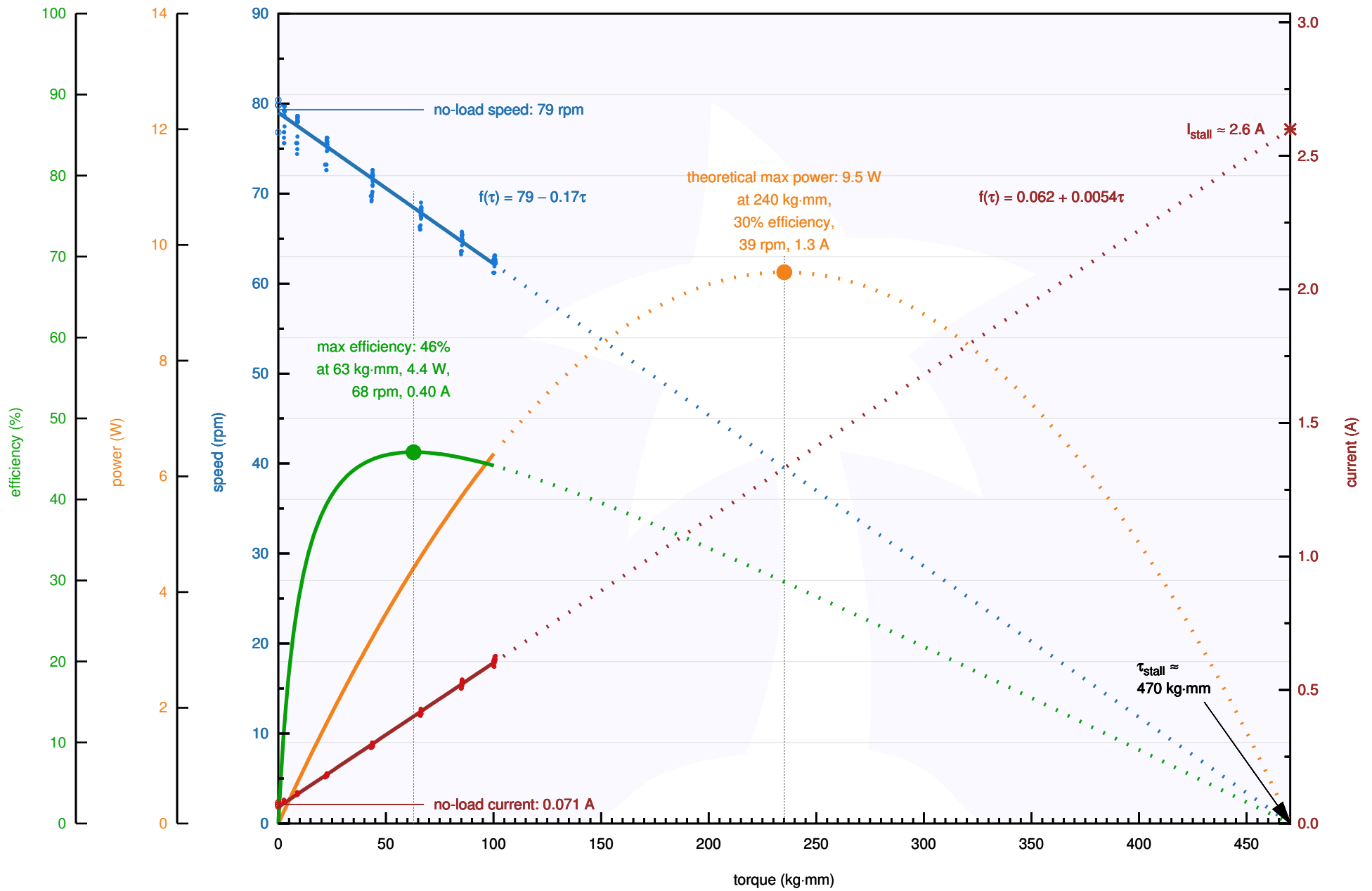

# Pololu Items #4686, #4696 (131:1 Metal Gearmotor 37D 24V) Performance at 12 V

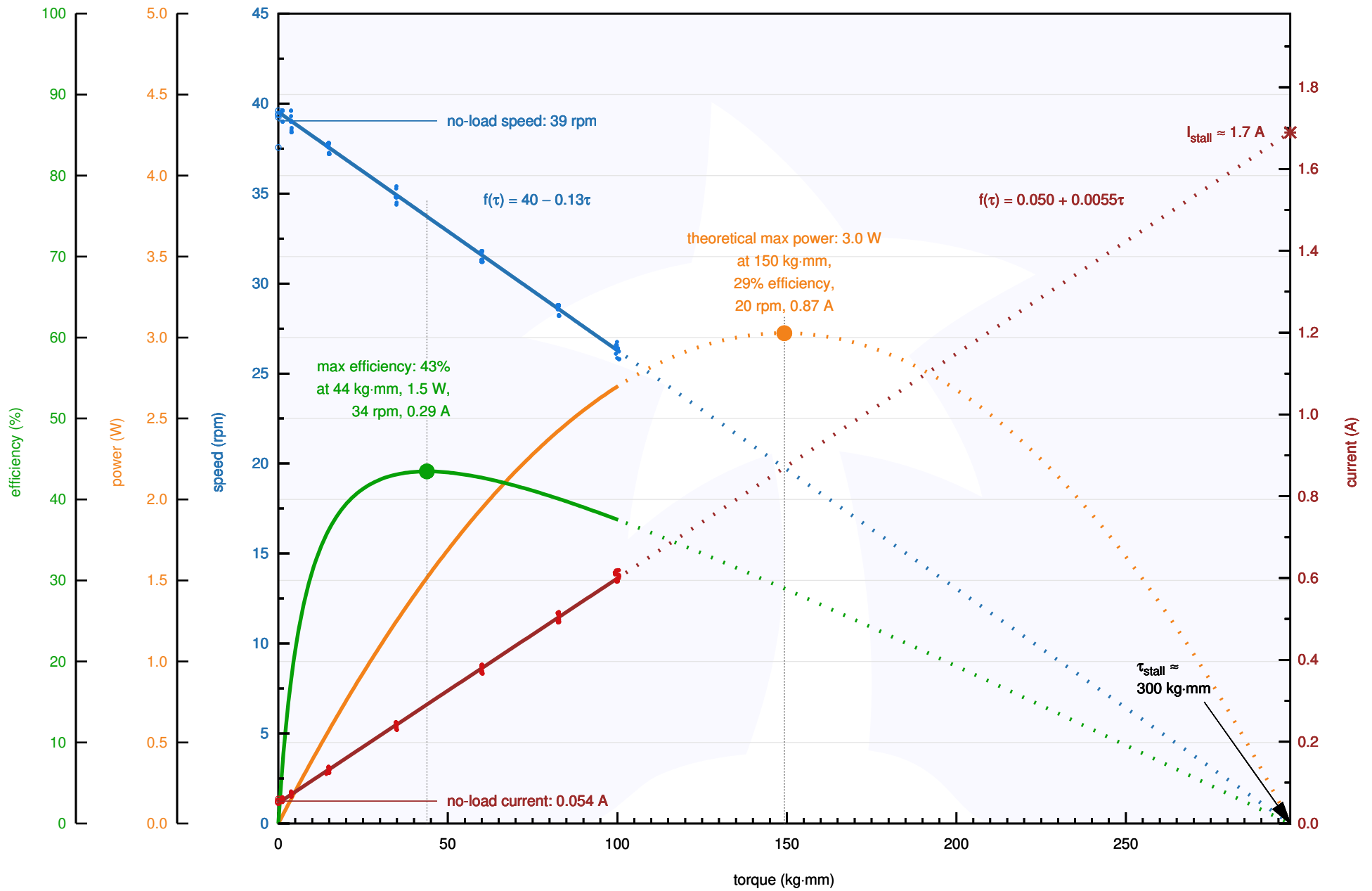

# Pololu Items #4687, #4697 (150:1 Metal Gearmotor 37D 24V) Performance at 24 V

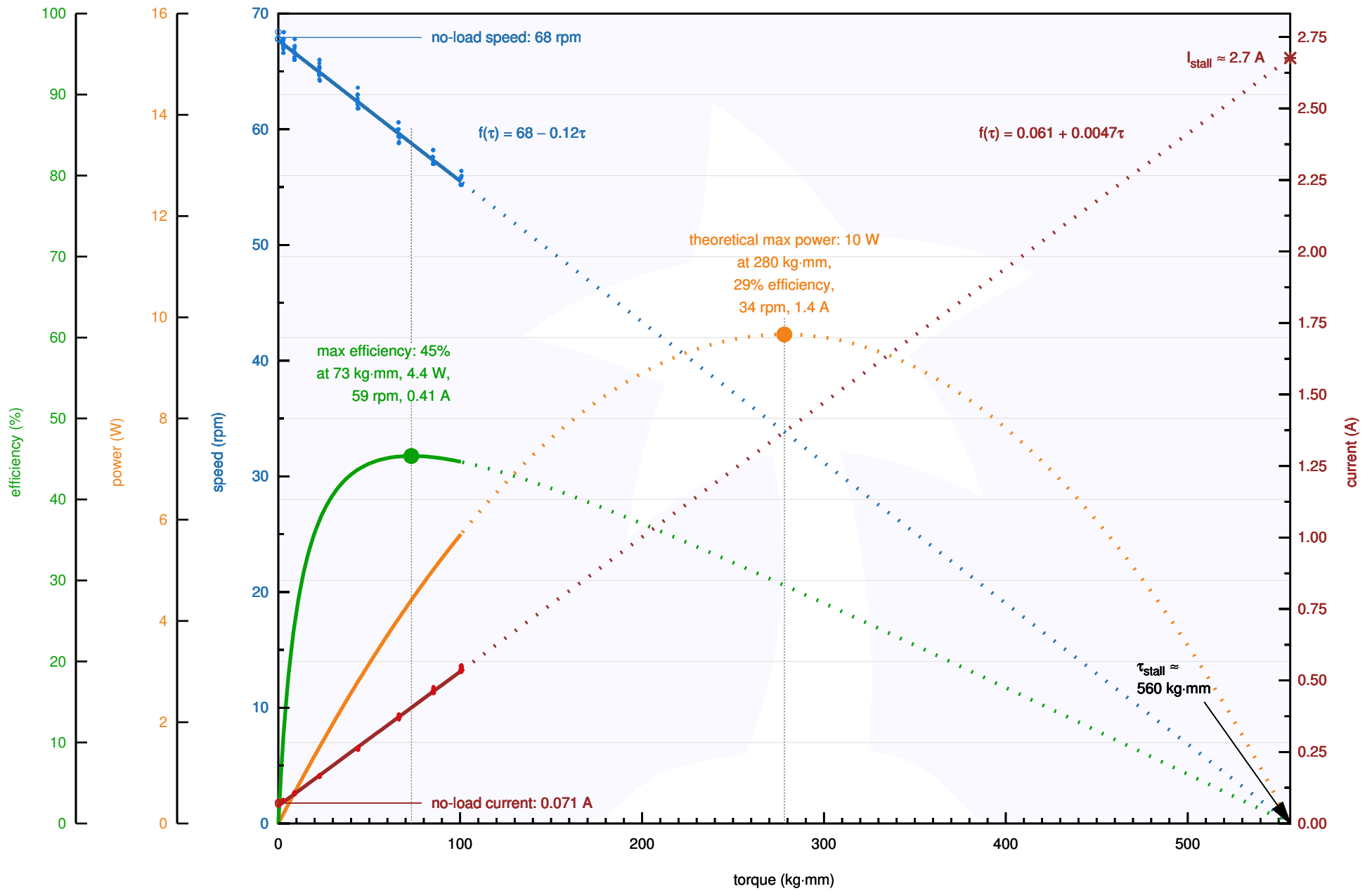

# Pololu Items #4687, #4697 (150:1 Metal Gearmotor 37D 24V) Performance at 12 V

